



# HP203

Roland Digital Piano  
Owner's Manual

Roland®



**WARNING:** To reduce the risk of fire or electric shock, do not expose this apparatus to rain or moisture.

	<b>CAUTION</b> RISK OF ELECTRIC SHOCK DO NOT OPEN	
<b>ATTENTION:</b> RISQUE DE CHOC ELECTRIQUE NE PAS OUVRIR		
<b>CAUTION:</b> TO REDUCE THE RISK OF ELECTRIC SHOCK, DO NOT REMOVE COVER (OR BACK). NO USER-SERVICEABLE PARTS INSIDE. REFER SERVICING TO QUALIFIED SERVICE PERSONNEL.		



The lightning flash with arrowhead symbol, within an equilateral triangle, is intended to alert the user to the presence of uninsulated "dangerous voltage" within the product's enclosure that may be of sufficient magnitude to constitute a risk of electric shock to persons.



The exclamation point within an equilateral triangle is intended to alert the user to the presence of important operating and maintenance (servicing) instructions in the literature accompanying the product.

INSTRUCTIONS PERTAINING TO A RISK OF FIRE, ELECTRIC SHOCK, OR INJURY TO PERSONS.

## IMPORTANT SAFETY INSTRUCTIONS SAVE THESE INSTRUCTIONS

**WARNING** - When using electric products, basic precautions should always be followed, including the following:

1. Read these instructions.
2. Keep these instructions.
3. Heed all warnings.
4. Follow all instructions.
5. Do not use this apparatus near water.
6. Clean only with a dry cloth.
7. Do not block any of the ventilation openings. Install in accordance with the manufacturers instructions.
8. Do not install near any heat sources such as radiators, heat registers, stoves, or other apparatus (including amplifiers) that produce heat.
9. Do not defeat the safety purpose of the polarized or grounding-type plug. A polarized plug has two blades with one wider than the other. A grounding type plug has two blades and a third grounding prong. The wide blade or the third prong are provided for your safety. If the provided plug does not fit into your outlet, consult an electrician for replacement of the obsolete outlet.
10. Protect the power cord from being walked on or pinched particularly at plugs, convenience receptacles, and the point where they exit from the apparatus.
11. Only use attachments/accessories specified by the manufacturer.
12. Use only with the cart, stand, tripod, bracket, or table specified by the manufacturer, or sold with the apparatus. When a cart is used, use caution when moving the cart/apparatus combination to avoid injury from tip-over.
13. Unplug this apparatus during lightning storms or when unused for long periods of time.
14. Refer all servicing to qualified service personnel. Servicing is required when the apparatus has been damaged in any way, such as power-supply cord or plug is damaged, liquid has been spilled or objects have fallen into the apparatus, the apparatus has been exposed to rain or moisture, does not operate normally, or has been dropped.



For the U.K.

**IMPORTANT:** THE WIRES IN THIS MAINS LEAD ARE COLOURED IN ACCORDANCE WITH THE FOLLOWING CODE.

BLUE: NEUTRAL  
BROWN: LIVE

As the colours of the wires in the mains lead of this apparatus may not correspond with the coloured markings identifying the terminals in your plug, proceed as follows:  
The wire which is coloured BLUE must be connected to the terminal which is marked with the letter N or coloured BLACK.  
The wire which is coloured BROWN must be connected to the terminal which is marked with the letter L or coloured RED.  
Under no circumstances must either of the above wires be connected to the earth terminal of a three pin plug.

**Before using this unit, carefully read the sections entitled: "IMPORTANT SAFETY INSTRUCTIONS," "USING THE UNIT SAFELY" (p. 6), and "Important Notes" (p. 9). These sections provide important information concerning the proper operation of the unit. Additionally, in order to feel assured that you have gained a good grasp of every feature provided by your new unit, owner's manual should be read in its entirety. The manual should be saved and kept on hand as a convenient reference.**

Copyright © 2006 ROLAND CORPORATION

All rights reserved. No part of this publication may be reproduced in any form without the written permission of ROLAND CORPORATION.

# Introduction

Thank you, and congratulations on your choice of the HP203. To ensure that you obtain the maximum enjoyment and take full advantage of the HP203's functionality, please read this owner's manual carefully.

## About the Manual

You should first read the "Before You Play" section of the owner's manual (this document). This explains how to connect the power cord and turn on the power. This owner's manual explains everything from basic operations that use the HP203's playback functions to more advanced operations, such as using the HP203 to record a song.

## Conventions in this Manual

In order to explain the operations as clearly as possible, this manual uses the following conventions.

- Text enclosed in square brackets [ ] indicates the name of a button or a knob, such as the [Piano] button.
- Lines that begin with **NOTE** or an asterisk \* are cautionary statements that you must be sure to read.
- The numbers of pages that you can turn to for additional, related information are given like this: (p. \*\*).

## Main Features

### Piano sounds with rich resonance and wide expressive range

This instrument features a piano sound generator that utilizes stereo sampling, so it is capable of faithfully recreating the sound of a high-quality concert grand piano, realistically reproducing even the finest details, including the sound of the hammers striking the strings. With a maximum polyphony of 128 notes, it has ample capability even for performances that make full use of pedaling.

More than three hundred different sounds covering not only piano but a wide range of instruments are built-in. You can also play drum sets from the keyboard.

### **The playing feel of a grand piano**

---

The Progressive Hammer Action II (PHA II) action gives you a weighty playing feel in the low register while becoming lighter in the high register, replicating the authentic feel of a piano. The distinctive sense of click (escapement) that you experience when softly playing a piano note is also accurately simulated, ensuring a high degree of playability. The pedal position is detected smoothly, allowing you to vary the effect by the changing the depth to which you press the pedal. You can take advantage of the way in which subtle differences in pedaling will affect the sound.

### **A compact cabinet that fits anywhere**

---

The newly designed cabinet is compact and exudes a sense of quality befitting a musical instrument. It can be placed nearly anywhere, and does not occupy excessive space. In addition to a sliding keyboard cover that will not rattle, there's a convenient headphone hook for storing your headphones when not in use.

### **The versatile functionality you expect from a digital piano**

---

#### **Replicating the ambience of a concert hall**

In addition to a high-quality reverb effect, these instruments also feature a 3D Sound Control function, which replicates the spatial depth of a full concert grand piano, and a Dynamic Sound Control function, which enhances the consistency and power of the sound. Even when performing through headphones, you can use these effects to enjoy sounds with superb presence.

#### **Convenient functions to help you practice, and built-in piano songs with accompaniment**

A metronome function, a three-track recorder, and internal preset songs with orchestral accompaniment and printed piano music (sixty songs) are included, making this electronic piano an excellent choice for piano lessons.

#### **Performing and saving data**

The data you've recorded using the recorder can be saved using a separately sold floppy disk drive or USB memory. In addition to a floppy disk drive or USB memory, you can also connect a commercially available USB-type CD drive and play back SMF music data, music CDs, or audio files. SMF music data from USB memory, a floppy disk, or CD-ROM can also be saved in internal memory.

# Contents



<b>Introduction .....</b>	<b>2</b>	Dividing the Keyboard for Two-person Performance (Twin Piano).....	31
About the Manual.....	2	Changing the Way in Which the Sound is Heard (Twin Piano Mode) .....	32
Conventions in this Manual.....	2	Performing With Two Layered Tones (Dual Play).....	33
Main Features .....	2	Changing the Tone Variations.....	34
<b>USING THE UNIT SAFELY .....</b>	<b>6</b>	Changing the Volume Balance for Dual Play.....	34
<b>Important Notes .....</b>	<b>9</b>	Performing with Different Tones in the Left and Right Sides of the Keyboard (Split Play).....	35
<b>Names of Things and What They Do .....</b>	<b>12</b>	Switching Tone Groups and Tone Variations.....	36
Front Panel .....	12	Changing the Keyboard's Split Point.....	36
Rear Panel (Bottom).....	14	Performing with the Metronome.....	37
Bottom Panel (Front Left) .....	15	Changing the Tempo .....	37
Bottom Panel (Front Right) .....	15	Changing the Beat .....	38
Installing the Floppy Disk Drive.....	15	Changing the Volume .....	39
<b>Before You Play .....</b>	<b>16</b>	Sounding a Count to Keep your Timing Accurate.....	39
Getting Ready to Play .....	16	<b>Playing Back Songs .....</b>	<b>40</b>
Connecting the Pedal Cord.....	16	Listening to Songs.....	40
Connecting the Power Cord.....	16	Playing Back All Songs Continuously (All Song Play).....	43
Setting Up the Music Rest .....	17	Listening to Each Part Separately .....	44
Opening/Closing the Lid.....	17	Determining the Volume of a Muted Part .....	45
Turning the Power On/Off.....	18	Changing the Song Playback Volume .....	45
Adjusting the Sound's Volume and Brilliance.....	18	Adjusting the Volume of the Audio Files and Music CDs.....	45
About the Pedals .....	19	Changing the Tempo of a Song .....	46
Listening through Headphones.....	20	Playing Back at a Fixed Tempo (Tempo Mute).....	46
Using the Headphone Hook.....	20	Changing the Key of the Song Playback (Playback Transpose) .....	47
Using External Memory .....	21	Minimizing the Center Sounds in the Playback (Center Cancel) .....	48
Connecting USB Memory .....	21	<b>Recording.....</b>	<b>49</b>
Using CD.....	21	Recording Your Keyboard Performance.....	50
Connecting a CD Drive .....	21	Recording Your Performance Separately for Each Hand.....	52
Recording.....	21	Recording Your Playing Along with a Song .....	55
Connecting a CD Drive .....	21	Erasing Recorded Performances .....	57
<b>Listening to Demo Songs.....</b>	<b>22</b>	<b>Saving Your Performance .....</b>	<b>58</b>
Listening to the Tone Demo Songs.....	22	Initializing the Memory.....	58
Listening to the Piano Sound Demo Songs.....	23	Saving the Songs.....	60
<b>Performing.....</b>	<b>25</b>	Deleting a Song .....	62
Performing with a Variety of Sounds .....	25		
Adjusting the Keyboard Sensitivity (Key Touch).....	26		
Adding Spatial Depth to the Sound (3D Sound Control).27			
Adding Liveliness to the Sound (Dynamics Sound Control) .....	28		
Adding Reverberation to Sounds (Reverb Effect) .....	29		
Changing the Depth of Reverb Effect.....	29		
Changing the Key of the Keyboard (Key Transpose).....	30		

<b>Various Settings .....</b>	<b>64</b>	<b>Other Settings .....</b>	<b>75</b>
Basic Operation in Function Mode.....	64	Using the V-LINK Function (V-LINK) .....	75
Changing How Grand Space is Applied (3D Mode) .	65	Changing the USB Driver Settings (USB Driver) .....	76
Keyboard Settings .....	66	Changing the External Memory Setting	
Specifying What the Key Transpose Will Affect		(External Memory Mode).....	76
(Transpose Mode).....	66	Adjusting the Volume (Master Gain) .....	77
Changing the Pitch of the Tone in Octave Steps		Changing the Parts Assigned to the Track Buttons	
(Octave Shift) .....	66	During SMF Playback (Track Assign).....	77
Changing the Timing of Sounds According to the		Switching VIMA TUNES Recommended Tones	
Force Used to Press the Keys (Hammer Response) .....	66	(Recommended Tone).....	78
Pedal Settings .....	67	Remembering the Settings (Memory Backup) .....	78
Changing How the Damper Pedal Effects Is Applied		Restoring the Settings to the Factory Condition	
(Damper Pedal Part).....	67	(Factory Reset).....	79
Changing How the Pedals Work		Disabling the Buttons (Panel Lock) .....	79
(Center/Left Pedal Function) .....	67		
Tuning Settings .....	68	<b>Connecting to Other Devices .....</b>	<b>80</b>
Matching the Pitch with Other Instruments		Connecting to Audio Equipment .....	80
(Master Tuning) .....	68	Connecting Speakers to the HP203 and Outputting	
Adjusting the Tuning (Temperament).....	68	Sounds.....	80
Stretched Tuning.....	69	Playing Sounds of an Audio Device through the	
Sound-related Settings .....	70	HP203 .....	81
Producing Sympathetic Resonance When You Press		Connecting to MIDI Devices.....	82
the Damper Pedal (Damper Resonance).....	70	Connecting a MIDI Sequencer to the HP203.....	82
Producing the Resonance of the Strings When the		Producing Sounds from a MIDI Sound Module by	
Keys Are Played (String Resonance).....	70	Playing the HP203 .....	82
Playing Sounds When the Keys Are Released		Connecting a Computer .....	83
(Key Off Resonance) .....	70		
Metronome Settings .....	71	<b>Troubleshooting.....</b>	<b>84</b>
Changing the Sound of the Metronome		<b>Error Messages.....</b>	<b>87</b>
(Metronome Sound) .....	71	<b>Tone List.....</b>	<b>88</b>
Count-down Setting.....	71	<b>Internal Song List .....</b>	<b>95</b>
Sounding a Count Before the Melody Begins		<b>Parameters Stored in Memory Backup .....</b>	<b>96</b>
(Countdown).....	71	<b>Music Files That the HP203 Can Use .....</b>	<b>97</b>
Selecting the Count-down Sound		<b>MIDI Implementation Chart .....</b>	<b>98</b>
(Countdown Sound) .....	71	<b>Main Specifications.....</b>	<b>99</b>
Selecting the Part that Will Begin the Count-down		<b>Index .....</b>	<b>101</b>
(Countdown Part).....	72		
Song Playback Settings .....	72		
Switching the Part that Will be Muted When You			
Press the [Accomp] Button (Accomp Track).....	72		
MIDI Settings.....	73		
Preventing Doubled Notes When Connected to a			
Sequencer (Local Control) .....	73		
MIDI Transmit Channel Settings			
(MIDI Transmit Channel) .....	74		
Sending Recorded Performance Data to a MIDI			
Device (Composer MIDI Out) .....	74		







# USING THE UNIT SAFELY

## INSTRUCTIONS FOR THE PREVENTION OF FIRE, ELECTRIC SHOCK, OR INJURY TO PERSONS

About  WARNING and  CAUTION Notices

 <b>WARNING</b>	Used for instructions intended to alert the user to the risk of death or severe injury should the unit be used improperly.
 <b>CAUTION</b>	Used for instructions intended to alert the user to the risk of injury or material damage should the unit be used improperly. * Material damage refers to damage or other adverse effects caused with respect to the home and all its furnishings, as well to domestic animals or pets.

About the Symbols

	The  symbol alerts the user to important instructions or warnings. The specific meaning of the symbol is determined by the design contained within the triangle. In the case of the symbol at left, it is used for general cautions, warnings, or alerts to danger.
	The  symbol alerts the user to items that must never be carried out (are forbidden). The specific thing that must not be done is indicated by the design contained within the circle. In the case of the symbol at left, it means that the unit must never be disassembled.
	The  symbol alerts the user to things that must be carried out. The specific thing that must be done is indicated by the design contained within the circle. In the case of the symbol at left, it means that the power-cord plug must be unplugged from the outlet.

### ALWAYS OBSERVE THE FOLLOWING

#### WARNING

##### Do not disassemble or modify

Do not disassemble or modify this device.





##### Do not repair or replace parts

Never attempt to repair this device or replace parts. If repair or part replacement should become necessary, you must contact your dealer or a Roland service center.



##### Do not use or store in the following types of locations

- Locations of extremely high temperature (such as in direct sunlight, near heating equipment, or on a device that generates heat) 
- Near moisture (such as in a bathroom, near a sink, or on a wet floor) or in locations of high humidity 
- Locations exposed to rain
- Locations of excessive dust
- Locations subject to heavy vibration

##### Do not place in an unstable location

Do not place this device on an unstable stand or a tilted surface. You must place it in a stable and level location. 

##### Connect the power cord to an outlet of the correct voltage

You must connect the power cord to an AC outlet of the correct voltage as marked on the device. 

#### WARNING

##### Use only the included power cord

You must use only the power cord included with the device. Do not use the included power cord with any other device. 

##### Do not bend the power cord or place heavy objects on it

Do not bend the power cord excessively, or place heavy objects on the power cord. Doing so will damage the power cord, and may cause short circuits or faulty connections, possibly resulting in fire or electrical shock. 

##### Do not share an outlet with an unreasonable number of other devices

Do not connect excessive numbers of electrical devices to a single power outlet. In particular, when using a power strip, exceeding the rated capacity (watts/amps) of the power strip may cause heat to be generated, possibly melting the cable. 

##### Avoid extended use at high volume

This device, either by itself or used in conjunction with headphones, amps, and/or speakers, is capable of producing volume levels that can cause permanent hearing damage. If you experience impaired hearing or ringing in your ears, immediately stop using the device and consult a medical specialist. 

##### Do not insert foreign objects

Never allow foreign objects (flammable objects, coins, wires, etc.) to enter this device. This can cause short circuits or other malfunctions. 



**⚠ WARNING**

**Turn off the power if an abnormality or malfunction occurs**

If any of the following should occur, immediately turn off the power, disconnect the power cord from the AC outlet, and contact your dealer or a service center to have the device serviced.



- The power cord is damaged
- The device produces smoke or an unusual smell
- A foreign object enters the device, or liquid spills into the device
- The device becomes wet (by rain, etc.)
- An abnormality or malfunction occurs in the device

**Do not allow children to use without supervision**

In households with children, take particular care against tampering. If children are to use this device, they must be supervised or guided by an adult.



**Do not drop or subject to strong impact**

Do not drop this device or subject it to strong impact.



**Do not use overseas**

If you wish to use this device overseas, please contact your dealer or a service center.



**Do not place containers of water on the device**

Do not place containers of water (such as a flower vase) or drinks on the device. Nor should you place containers of insecticide, perfume, alcoholic liquids, nail polish, or spray cans on the device. Liquids that spill into the device may cause it to malfunction, and may cause short circuits or faulty operation.



**⚠ CAUTION**

**Place in a well ventilated location**

When using this device, ensure that it is placed in a well ventilated location.



**Grasp the plug when connecting or disconnecting the power cord**

When connecting or disconnecting the power cord to/from an AC outlet or the device itself, you must grasp the plug, not the cord.



**Periodically wipe the dust off the power cord plug**

From time to time, you should unplug the power cord from the AC outlet and use a dry cloth to wipe the dust off of it. You should also unplug the power cord from the AC outlet if you will not be using the device for an extended period of time. Dust or dirt that accumulates between the power cord plug and the AC outlet can cause a short circuit, possibly resulting in fire.



**Manage cables for safety**

Ensure that the connected cables are organized and managed in a safe manner. In particular, place the cables out of reach of children.



**Do not stand or place heavy objects on this device**

Do not stand on this device, or place heavy objects on it.



**Do not connect or disconnect the power cord with wet hands**

Do not connect or disconnect the power cord to the device or AC outlet while holding the power cord plug with wet hands.



**Cautions when moving this device**

When moving this device, please check the following cautions. Then, make sure that at least two persons work together in lifting and carrying the device, all the while making sure to keep it level. When doing so, be careful not to pinch your hands or drop the device on your feet.



- Check whether the knob bolts fastening the device to its stand have become loose. If they are loose, tighten them firmly.
- Disconnect the power cord.
- Disconnect external devices.
- Raise the adjuster of the stand.
- Close the lid.
- Remove the music stand.

 **CAUTION**

### Unplug the power cord from the AC outlet before cleaning

Before you clean the device, turn off the power and unplug the power cord from the AC outlet.



---

### If there is a possibility of lightning strike, disconnect the power cord from the AC outlet

If there is a possibility of lightning strike, immediately turn off the power and disconnect the power cord from the AC outlet.



---

### Cautions when opening/closing the lid

Be careful when opening/closing the lid so you do not get your fingers pinched (p. 16). Adult supervision is recommended whenever small children use the unit.



---

### Keep small items out of the reach of children

To prevent small items such as the following from being swallowed accidentally, keep them out of the reach of children.



- Included items
  - Screws for assembling the stand
  - Wing nut for headphone hook
- Removed parts
  - Music rest attachment screws
  - Volume knob

# Important Notes

In addition to the "USING THE UNIT SAFELY" listed on page 6, please observe the following cautions.

## Power Supply

- Do not connect this device to the same electrical outlet as an inverter-controlled device such as a refrigerator, microwave oven, or air conditioner, or a device that contains an electric motor. Depending on how the other device is used, power supply noise could cause this device to malfunction or produce noise. If it is not practical to use a separate electrical outlet, please connect this device via a power supply noise filter.
- Before you make connections, you must switch off the power on all devices to prevent malfunction and/or speaker damage.
- When you turn off the power, the screen and indicators of this device will go dark, but this does not mean that the main power supply is completely disconnected. If you need to completely shut off the power supply, turn off the power switch of this device and then unplug it from the AC outlet. Connect this device to an AC outlet that is as close and accessible as possible.

## Location

- If this device is placed near devices that contain large transformers, such as power amps, hum may be induced in this device. If this occurs, move this device farther away or change its orientation.
- If this device is operated near a television or radio, color distortion may be seen in the television screen or noise may be heard from the radio. If this occurs, move this device farther away.
- Keep your cell phone powered off or at a sufficient distance from this device. If a cell phone is nearby, noise may be heard when a call is received or initiated, or during conversation.
- Do not leave this device in direct sunlight, near devices that produce heat, or in a closed-up automobile. Do not allow illumination devices operated in close proximity (such as a piano light) or powerful spotlights to shine on the same location on this device for an extended time. This can cause deformation or color change.

- If you move this device between locations of radically different temperature or humidity, water droplets (condensation) may form inside the device. Using the device in this condition will cause malfunctions, so please allow several hours for the condensation to disappear before you use the device.
- Do not allow items made of rubber or vinyl to remain on top of this device for an extended time. This can cause deformation or color change.
- Do not leave objects on top of the keyboard. This can cause malfunctions such as failure to sound.
- Do not affix adhesive labels to this device. The exterior finish may be damaged when you remove the labels.

## Care

- For everyday care, wipe with a soft dry cloth, or remove stubborn dirt using a tightly wrung-out cloth. If this device contains wooden components, wipe the entire area following the direction of the grain. The finish may be damaged if you continue strongly rubbing a single location.
- If water droplets should adhere to this device, immediately wipe them off using a soft dry cloth.
- Do not use solvents such as benzene, thinner, or alcohol, since these can cause deformation or color change.
- The pedals of this device are made of brass. Brass has a natural tendency to oxidize and become tarnished. If this occurs, use a commercially available metal polish.

## Servicing

- If you return this device for servicing, the contents of memory may be lost. Please store important contents on USB memory, or make a note of the contents. We take utmost care to preserve the contents of memory when performing service, but there may be cases when the stored content cannot be recovered because the memory section has malfunctioned. Please be aware that we cannot accept responsibility for the recovery of lost memory content or for any consequences of such loss.

### Other Cautions

- Stored content may be lost due to a malfunction of the device or because of inadvertent operation. You should back up important content on USB memory as a safeguard against such loss.
- We cannot accept responsibility for the recovery of any content lost from internal memory or USB memory, or for the consequences of such loss.
- Do not apply excessive force to the buttons, knobs, or input/output jacks, since this may cause malfunctions.
- When connecting or disconnecting cables, grasp the plug (not the cable) to prevent short circuits or broken connections.
- This device may produce a certain amount of heat, but this is not a malfunction.
- Please enjoy your music in ways that do not inconvenience other people nearby, and pay particular attention to the volume at nighttime. Using headphones will allow you to enjoy music without having to be concerned about others.
- When transporting or shipping this device, package it in an appropriate amount of cushioning material. Scratches, damage, or malfunctions may occur if you transport it without appropriate packaging.
- If using the music rest, do not apply excessive force to it.
- Some connection cables contain a resistor. Do not connect such cables to this device. Doing so may make the volume extremely low or inaudible. Please use connection cables not containing a resistor.
- Before opening or closing the keyboard lid, always make sure that no pets or other small animals are located on top of the instrument (in particular, they should be kept away from the keyboard and its lid). Otherwise, due to the structural design of this instrument, small pets or other animals could end up getting trapped inside it. If such a situation is encountered, you must immediately switch off the power and disconnect the power cord from the outlet. You should then consult with the retailer from whom the instrument was purchased, or contact the nearest Roland Service Center.

### Floppy Disk Handling

#### (Using Optional Floppy Disk Drive)

- Floppy disks contain a plastic disk with a thin coating of magnetic storage medium. Microscopic precision is required to enable storage of large amounts of data on such a small surface area. To preserve their integrity, please observe the following when handling floppy disks:
  - Never touch the magnetic medium inside the disk.
  - Do not use or store floppy disks in dirty or dusty areas.
  - Do not subject floppy disks to temperature extremes (e.g., direct sunlight in an enclosed vehicle). Recommended temperature range: 10–50 degrees C (50–122 degrees F).
  - Do not expose floppy disks to strong magnetic fields, such as those generated by loudspeakers.
- Floppy disks have a “write protect” tab which can protect the disk from accidental erasure. It is recommended that the tab be kept in the PROTECT position, and moved to the WRITE position only when you wish to write new data onto the disk.

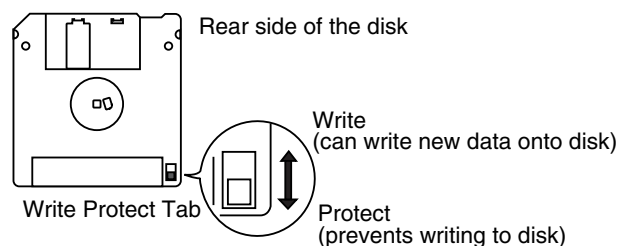

- The identification label should be firmly affixed to the disk. Should the label come loose while the disk is in the drive, it may be difficult to remove the disk.
- Store all disks in a safe place to avoid damaging them, and to protect them from dust, dirt, and other hazards. By using a dirty or dust-ridden disk, you risk damaging the disk, as well as causing the disk drive to malfunction.

## USB Memory Handling

- When connecting USB memory, firmly insert it all the way in.
- Do not touch the pins of the USB memory connector, or allow them to become dirty.
- USB memory is made using high-precision electronic components, so please observe the following points when handling it.
  - To prevent damage from static electrical charges, discharge any static electricity that might be present in your body before handling USB memory.
  - Do not touch the terminals with your fingers or any metal object.
  - Do not bend or drop USB memory, or subject it to strong impact.
  - Do not leave USB memory in direct sunlight or in locations such as a closed-up automobile. (Storage temperature: 0–50 degrees C)
  - Do not allow USB memory to become wet.
  - Do not disassemble or modify USB memory.
- When connecting USB memory, position it horizontally with the external memory connector and insert it without using excessive force. The external memory connector may be damaged if you use excessive force when inserting USB memory.
- Do not insert anything other than USB memory (e.g., wire, coins, other types of device) into the external memory connector. Doing so will damage the external memory connector.
- Do not apply excessive force to the connected USB memory.
- If you will not be using USB memory for an extended period of time, close the USB memory cover.

## Handling the CDs (CD-ROMs)

- When handling the discs, please observe the following.
  - Do not touch the encoded surface of the disc.
  - Do not use in dusty areas.
  - Do not leave the disc in direct sunlight or an enclosed vehicle.
- Avoid touching or scratching the shiny underside (encoded surface) of the disc. Damaged or dirty CD-ROM discs may not be read properly. Keep your discs clean using a commercially available CD cleaner.
- Keep the disc in the case.
- Do not keep the disc in the CD drive for a long time.
- Do not put a sticker on the label of the disc.
- Wipe the disc with a soft and dry cloth radially from inside to outside. Do not wipe along circumference.
- Do not use benzine, record cleaner spray or solvents of any kind.
- Do not bend the disc. Bending discs may prevent proper reading and writing of data, and may further result in malfunction.

\* GS (  ) is a registered trademark of Roland Corporation.

\* XG lite (  ) is a registered trademark of Yamaha Corporation.

# Names of Things and What They Do

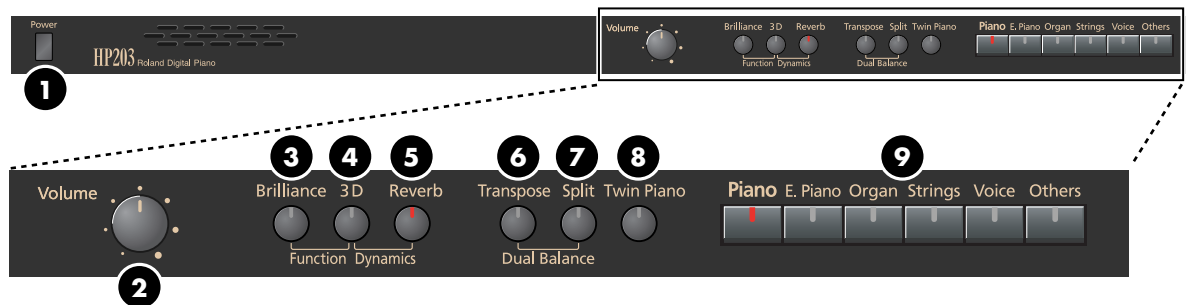

## Front Panel

### 1 [Power] switch

Turns the power on/off (p. 18).

### 2 [Volume] knob

Adjusts the overall volume of the HP203 (p. 18).  
If headphones are connected, this adjusts the headphone volume (p. 20).

### 3 [Brilliance] button

Adjusts the tone brightness (p. 18).  
You can also set a number of different functions when this button and the [3D] button are held down (p. 64).

### 4 [3D] button

Adds a sense of depth to the sound (p. 27).  
By holding down this button and pressing the [Reverb] button to change the setting, you can make the sound more expressive (p. 28).

### 5 [Reverb] button

Adds reverberation similar to what you would hear when performing in a concert hall (p. 29).

### 6 [Transpose] button

Transposes the keyboard and/or song (p. 30).  
By holding down this button and pressing the [Split] button, you can adjust the volume balance between the two sounds when using Dual performance (p. 34).

### 7 [Split] button

Divides the keyboard into right-hand and left-hand areas, allowing you to play a different sound in each area (p. 35).

### 8 [Twin Piano] button

Divides the keyboard into two separate sections, allowing two people to perform in the same registers (p. 31).

### 9 TONE buttons

Here you can select the sound (tone group) you'll hear when you play the keyboard (p. 25).

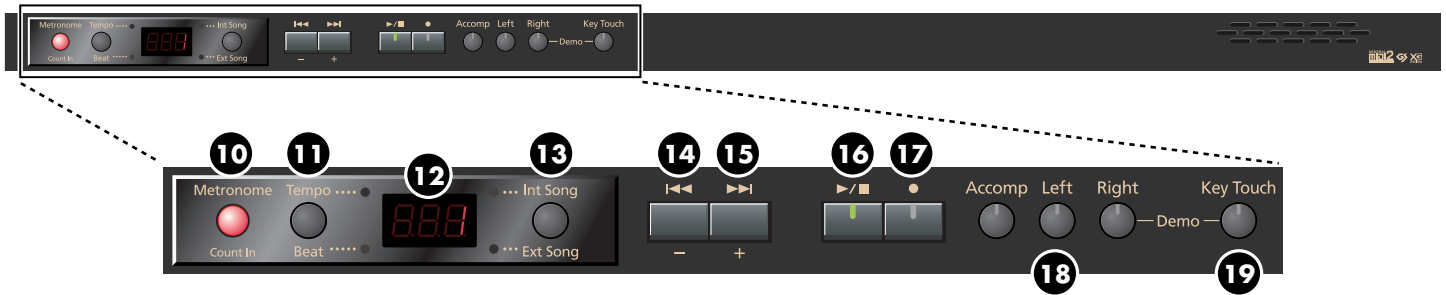

**10 [Metronome/Count In] button**

Turns the metronome on/off (p. 37).  
This also lets you sound a count before the song begins, so that you can match the timing of your playing to the song (p. 39).

**11 [Tempo/Beat] button**

Here you can adjust the tempo and beat of the metronome (p. 37).

**12 Display**

This shows the sound number, song number, tempo, time signature, and the value of various settings.

**13 [Int Song/Ext Song] button**

This lets you select the song to play back (p. 40).

**14 [◀◀] (-) button**

You can select the preceding song by pressing this button while the song select screen is displayed (p. 40).  
If you hold down this button while a song is playing, the song will be rewound (p. 41).  
Use this button to select variations of the sound you're playing on the keyboard (p. 25).  
This button is also used to edit various values.

**15 [▶▶] (+) button**

You can select the next song by pressing this button while the song select screen is displayed (p. 40).  
If you hold down this button while a song is playing, the song will be fast-forwarded (p. 41).  
Use this button to select variations of the sound you're playing on the keyboard (p. 25).  
This button is also used to edit various values.

**16 [▶/■] (Play/Stop) button**

Use this button to play/stop an internal preset song or a song you've recorded (p. 40).  
This button is also used to begin recording your performance (p. 49).

**17 [●] (Rec) button**

This lets you record your own performance into the HP203 (p. 49).

**18 Track buttons**

You can use these buttons to play back or record your performance separately for each hand (p. 44, p. 52).  
The right-hand performance of internal preset songs is assigned to the [Right] button, the left-hand performance to the [Left] button, and the remaining parts of the performance to the [Accomp] button.  
You can listen to the demo songs by holding down the [Right] button and pressing the [Key Touch] button (p. 22).

**19 [Key Touch] button**

This lets you adjust the touch sensitivity of the keyboard (p. 26).

## Rear Panel (Bottom)

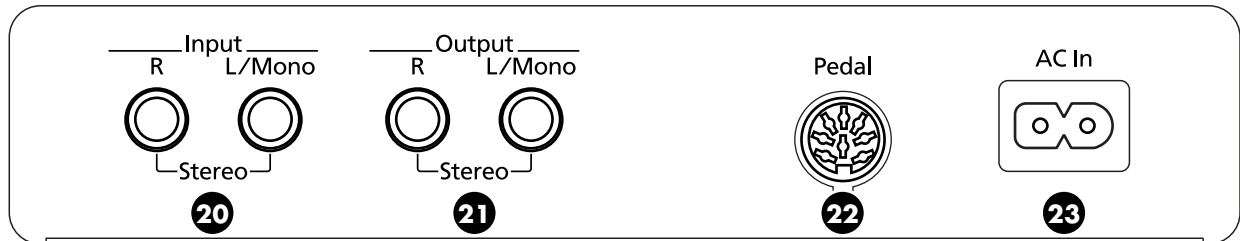

### 20 Input jacks (L/Mono, R)

Here you can connect an audio device or another electronic musical instrument, and listen to the connected device through the HP203's speakers (p. 81).

### 21 Output jacks (L/Mono, R)

You can connect an audio device or external powered speakers here to reproduce the HP203's sound (p. 80).

### 22 Pedal connector

Connect the pedal cord of the dedicated stand to this connector (p. 16).

### 23 Ac In (AC Inlet)

Connect the included power cord here (p. 16).



## Bottom Panel (Front Left)

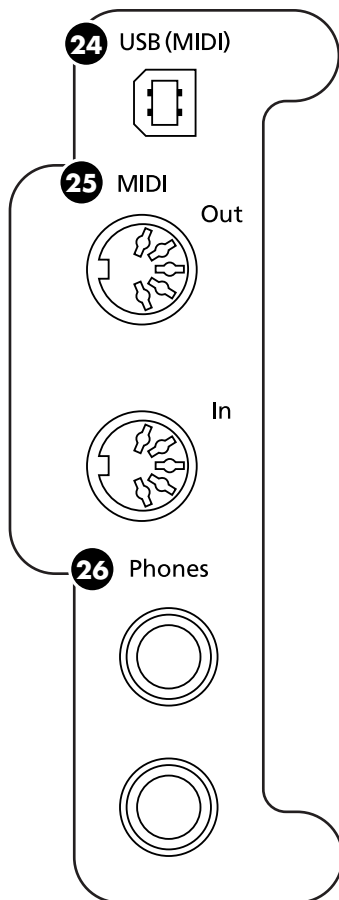

### 24 USB connector

You can connect this to your computer for transferring performance data (p. 83).

### 25 MIDI In/Out connectors

You can connect these to external MIDI devices to transfer performance data (p. 82).

### 26 Phones jacks

Here you can connect headphones. The HP203 lets you use two sets of headphones simultaneously (p. 20).

## Bottom Panel (Front Right)

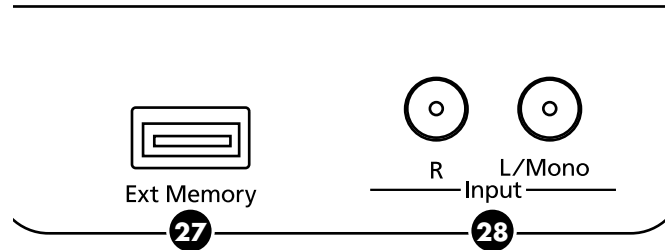

### 27 External Memory connector

Here you can connect USB memory, a floppy disk drive, or a CD drive, and play back stored songs (p. 40). You can also use USB memory to save a song you've recorded on the HP203 (p. 60).

## Installing the Floppy Disk Drive

Attach the floppy disk drive as shown the figure, using the mounting holes on the HP203's bottom panel.

\* For details of the attachment, refer to the owner's manual of the floppy disk drive.

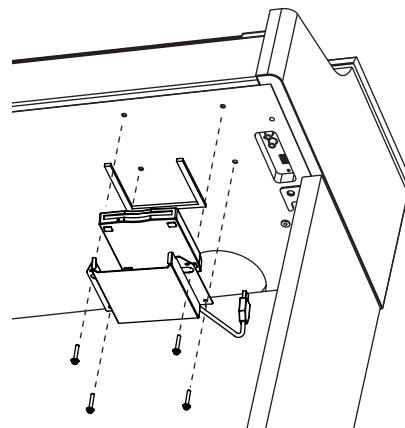

### 28 Input jacks (L/Mono, R)

Here you can connect an audio device or another electronic musical instrument, and listen to the connected device through the HP203's speakers (p. 81).

# Before You Play

## Getting Ready to Play

### Connecting the Pedal Cord

Plug the pedal cord extending from the stand into the Pedal connector located at the back of the HP203's bottom panel.

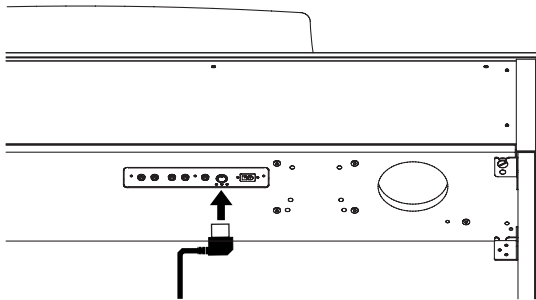

### Connecting the Power Cord

1. Make sure that the [Power] switch located at the left side of the front panel is off (in the upward position).

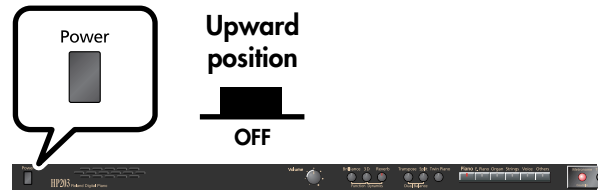

2. Turn the [Volume] knob all the way toward the left to minimize the volume.
3. Connect the included power cord to the AC INLET located at the rear of the bottom panel.
4. Plug the other end of the power cord into an AC outlet.

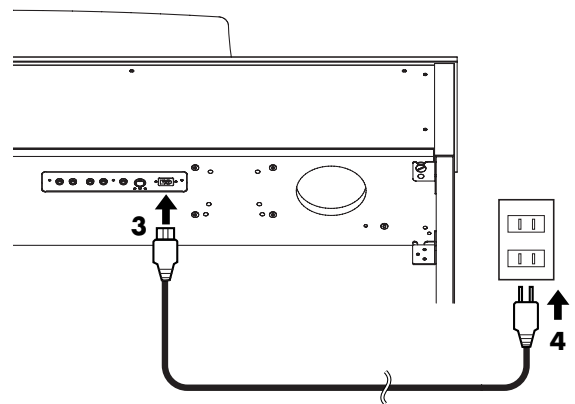

**NOTE** You must use the power cord included with the HP203.

## Setting Up the Music Rest

Attach the included music rest using the procedure described below.

- 1. Insert the included music rest attachment screws into the screw holes on top of the HP203, and tighten the screws slightly**

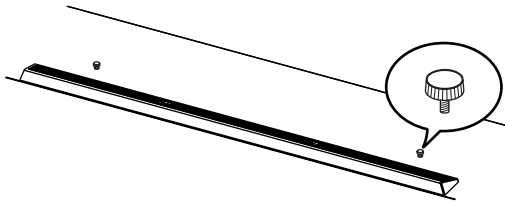

- 2. Put the music rest between the screws and the HP203's body.**

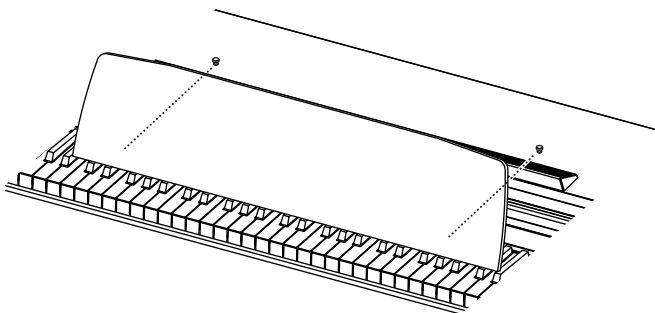

- 3. While supporting the music rest with one hand, secure it in place by turning the screws.**

When attaching the music rest, support it firmly with one hand to make sure that you don't drop it. Be careful, so you don't get your fingers pinched.

- 4. To remove the music rest, support it with one hand while loosening the screws.**

After removing the music rest, don't forget to retighten the screws.

**NOTE** Do not apply excessive force to the installed music rest.

**NOTE** Be sure to use the supplied screws for attaching the music rest.

**NOTE** Before moving the piano, be sure to remove the music rest to prevent accidents.

**NOTE** Be careful not to lose the screws used to fasten the music rest, or allow small children to accidentally swallow them.

## Using the music holders

You can use the holders to hold pages in place. When not using the holders, leave them folded down.

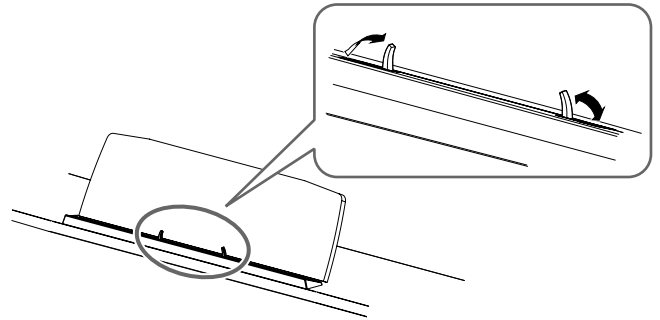

## Opening/Closing the Lid

To open the lid, use both hands to lift it lightly, and slide it away from yourself.

To close the lid, pull it gently toward yourself, and lower it softly after it has been fully extended.

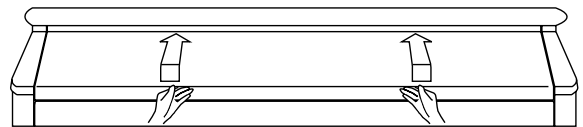

**NOTE** When opening and closing the lid, be careful not to let your fingers get caught. If small children will be using the HP203, adult supervision should be provided.

**NOTE** If you need to move the piano, make sure the lid is closed first to prevent accidents.

## Turning the Power On/Off

**NOTE** Once you've got everything connected properly, you can turn on the power using the following procedure. If you fail to perform these steps in the correct order, you risk causing a malfunction or damaging your speakers.

### Turning the Power On

1. Turn the [Volume] knob all the way toward the left to minimize the volume.

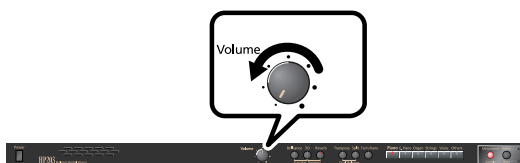

2. Press the [Power] switch.

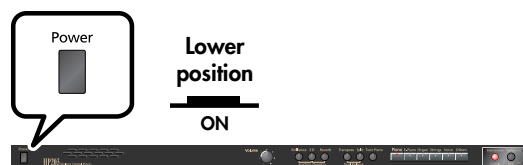

The power will turn on, and the [Piano] button will light. After a brief interval, you'll be able to produce sounds by playing the keyboard.

**NOTE** Due to a circuitry protection feature, this unit requires a few moments after power is turned on before it is ready for normal operation.

3. Use the [Volume] knob to adjust the volume.

### Turning the Power Off

1. Turn the [Volume] knob all the way toward the left to minimize the volume.



2. Press the [Power] switch.

The screen goes blank and the power is turned off.

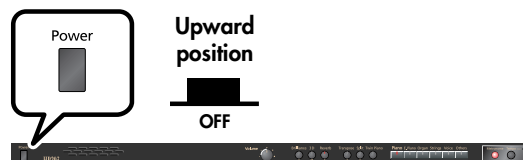

**NOTE** If you need to turn off the power completely, first turn off the [Power] switch, then unplug the power cord from the power outlet. Refer to "Power Supply" (p. 9).

## Adjusting the Sound's Volume and Brilliance

Here's how to adjust the volume of your keyboard playing or the playback volume of an internal song or USB memory song. If headphones are connected, use the [VOLUME] knob to adjust the headphone volume.

1. Turn the [VOLUME] knob to adjust the overall volume.

Adjust the volume while you play the keyboard to produce sound.

Turning the knob toward the right will increase the volume, and turning it toward the left will decrease the volume.

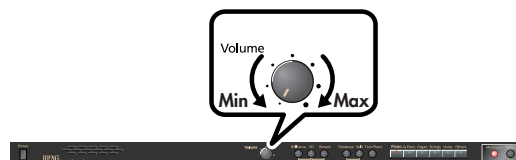

### Adjusting the brightness of the sound

1. Press the [Brilliance] button so it's lit.
2. While holding down the [Brilliance] button, use the [-] [+] buttons to adjust the brightness of the sound.

Press the [+] button to make the sound brighter.

Press the [-] button to make the sound more mellow.

Setting
-10-10

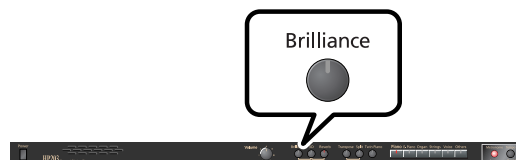

If you press the [Brilliance] button so it's no longer lighted, the sound will return to its original brightness.

**MEMO** You can use the Memory Backup function to store this setting in internal memory (p. 78).

## About the Pedals

The pedals perform the following operations. You'll use them mainly when playing piano.

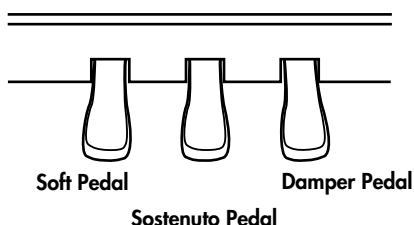

### Damper Pedal (right pedal)

Use this pedal to sustain the sound.

While this pedal is held down, notes will be sustained for an extended time even if you release your fingers from the keyboard.

The length of sustain will change subtly depending on how deeply you press the pedal.

On an acoustic piano, holding down the damper pedal will cause the strings for notes other than the ones you actually play to vibrate in sympathy with what you've played, producing a rich resonance. The HP203 simulates this sympathetic vibration (damper resonance).



You can modify the sound of the sympathetic vibration. Refer to p. 70.

### Sostenuto Pedal (center pedal)

The notes you are pressing when this pedal is depressed will be sustained.

### Soft Pedal (left pedal)

This pedal is used to make the sound softer.

Playing with the soft pedal depressed produces a sound that is not as strong as when otherwise played with the equivalent strength. This is the same function as the left pedal of an acoustic piano.

The softness of the tone can be varied subtly by the depth to which you press the pedal.



You can switch the function of the sostenuto pedal and the soft pedal. Refer to "Changing How the Pedals Work (Center/Left Pedal Function)" (p. 67).



If you disconnect the pedal cable from the HP203 while the power is turned on, the pedal effect will remain applied. You must connect or disconnect the pedal cable while the HP203's power is switched off.

## About the Adjuster

If you feel that the pedal is unstable (for example if you've moved the HP203 to a different location), you can adjust the adjuster located on the bottom of the pedals as follows.

- Turn the adjuster to lower it until the adjuster is in firm contact with the floor. The pedal may be damaged if there is a gap between the adjuster and the floor. In particular, when you've placed the HP203 on carpet, you must turn the adjuster until it is pressing firmly against the floor.

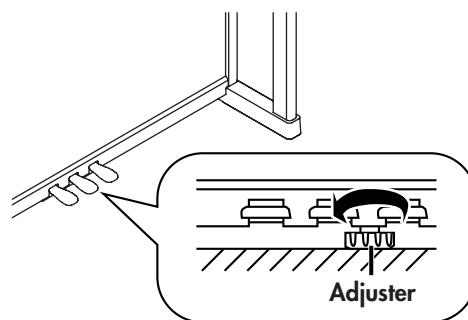

## Listening through Headphones

You can use headphones to enjoy the HP203 without disturbing those around you, such as at night. Since the HP203 has two headphone jacks, two people can also use headphones simultaneously.

If you're using only one set of headphones, you may connect them to either of the two headphone jacks.



- 1. Plug the headphones into the PHONES jack located at the left of the HP203's bottom panel.**

If headphones are connected, no sound will be output from the HP203's speakers.

- 2. Use the HP203's [VOLUME] knob (p. 18) to adjust the headphone volume.**

## Cautions when Using Headphones

- To prevent damage to the cord's internal conductors, avoid rough handling. When using headphones, mainly try to handle either the plug or the headset.
- Your headphones may be damaged if the volume of a device is already turned up when you plug them in. Minimize the volume before you plug in the headphones.
- Excessive input will not only damage your hearing, but may also strain the headphones. Please enjoy music at an appropriate volume.
- Use headphones that have a stereo 1/4" phone plug.

## Using the Headphone Hook

Whenever you are not using the headphones, you can hang them on the headphone hook of the HP203.

### Attaching the Headphone Hook

- 1. Press and twist the headphone hook included with the HP203 into the hole in the bottom left of the HP203 (refer to the figure below).**
- 2. Turn the headphone hook wing nut to secure the headphone hook.**

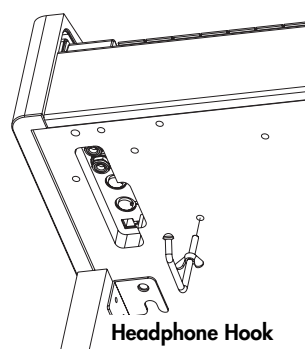

**NOTE**

Do not hang anything other than headphones on the headphone hook. Doing so may damage the instrument or the hook.

## Using External Memory

A song you've recorded on the HP203 can be saved by copying it to separately sold USB memory (p. 60).

You can also copy songs to a floppy disk using a separately sold floppy disk drive.

You can also play back SMF music data or audio files (p. 42) saved on USB memory or a floppy disk.

**NOTE** Use USB memory and floppy disk drive available from Roland. Proper operation cannot be guaranteed if other USB device is used.

## Connecting USB Memory

### 1. Connect the USB memory to the External Memory connector.

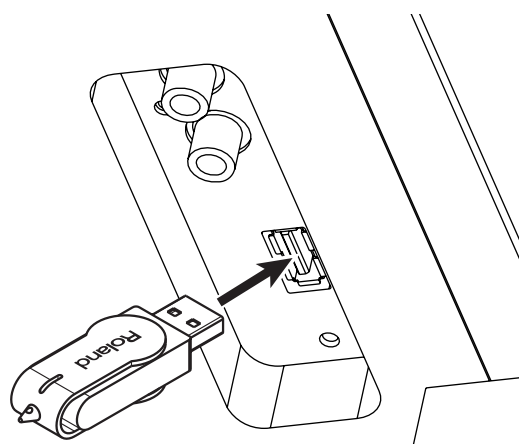

Carefully insert the USB memory all the way in—until it is firmly in place.

**MEMO** If you're using new USB memory, you'll need to initialize (format) it on the HP203. For details, refer to Initializing the USB memory (p. 58).

## Using CD

You can play back audio CDs and CD-ROMs containing saved SMF music files.

\* You can also play songs on VIMA CD-ROMs (VIMA TUNES) sold by Roland.

## Precautions Concerning Use of the CD

- You cannot play back CD-R/RW disks to which audio tracks have been added or CDs containing both audio tracks and data (CD Extra).
- The HP203 is capable of playing back only commercial CDs that conform the official standards—those that carry the "COMPACT DISC DIGITAL AUDIO" logo.
- The usability and sound quality of audio discs that incorporate copyright protection technology and other non-standard CDs cannot be guaranteed.
- For more detailed information on audio discs featuring copyright protection technology and other non-standard CDs, please consult the disc vendor.
- You cannot save songs to CDs, and you cannot delete songs recorded to CDs. Furthermore, you cannot format CDs.

## Connecting a CD Drive

\* CD drives that draw their power from the USB connector cannot be used.

1. Switch off the power to the HP203 and the CD drive to be connected.
2. Connect the USB cable included with the CD drive to the External Memory connector on the HP203.
3. Turn on the power to this instrument.
4. Turn on the power to the connected CD drive.

**NOTE** For information on how to perform the following CD-drive operations, refer to the owner's manual for the drive.

- Switching the power on and off
- Inserting and ejecting a CD

**MEMO** A list of the CD drives that have been tested and found to be compatible is available on the Roland website.

<http://www.roland.com/>

# Listening to Demo Songs

## Listening to the Tone Demo Songs

Now, try listening to demo songs.

The HP203 comes with seven demo songs.

The six Tone buttons and the [Twin Piano] button are each assigned one demo song.

**NOTE** All rights reserved. Unauthorized use of this material for purposes other than private, personal enjoyment is a violation of applicable laws.

**NOTE** No MIDI data for the music that is played will be output.



### 1. Hold down the [Right] button and press the [Key Touch] button.

The indicators for the Tone, [Twin Piano], and [Split] buttons flash.

The following appears in the display.



Button with tone demo	Demo content
[Piano]	Piano tone demo song
[E. Piano]	E.piano tone demo song
[Organ]	Organ tone demo song
[Strings]	Strings tone demo song
[Voice]	Demo song using Voice tones
[Others]	Demo song using Guitar tones
[Twin Piano]	Demo song using the Twin Piano function (p. 31)



**When the following appears in the display**

If you have recorded a song but have not yet saved it, "dEL" will appear, blinking, when you select a song.



You cannot play back a demo song if memory contains an unsaved song.

If you want to delete your performance and play back the demo song, press the [●] button. If you don't want to delete your performance, press the [▶/■] button. If you want to save your recorded performance, refer to p. 60.

**2. Press one of the six Tone buttons or the [Twin Piano] button.**

The songs will play consecutively, starting with the demo song you selected. The button for the song currently being played back flashes on and off.

When playback of the last song is reached, playback continues by returning to the first song and playing that again.

**3. To stop playback, press the flashing button.****4. Press the [Right] button or the [Key Touch] button to exit Demo mode.**

The indicators return to their previous state.

 A demo song will not play if you press an unlit button.

## Listening to the Piano Sound Demo Songs

In order to simulate the rich sounds typical of an acoustic piano, this instrument produces reverberation and a variety of other sounds together with the piano sound. This demo lets you compare how the piano sounds with and without these additional sounds.

**1. Hold down the [Right] button and press the [Key Touch] button.****2. Press the [Split] button.**

The indication in the display will change.

The [Brilliance], [Piano], and [E. Piano] buttons will blink, and the [3D] and [Reverb] buttons will light.

While the [Brilliance] button is blinking, you can listen to demos of the hammer noise and key-off resonance. Press the [3D] button if you want to hear the damper resonance demo, or press the [Reverb] button if you want to hear the string resonance demo.

When you press the [3D] button, the [Organ] button will also blink in addition to the [Piano] and [E.Piano] buttons.

**3. Press the [Piano] or [E. Piano] button.**

**4. Press the [Right] button or the [Key Touch] button to exit Demo mode.**

The indicators return to their previous state.

### [Brilliance] button



Button	Demo content	Sound that is played
[Piano]	Hammer Noise (the sound of the hammer striking the string when you play a note)	Each press of the button selects the next choice for what you will hear, in this order: Piano sound with hammer noise Piano sound without hammer noise Hammer noise by itself
[E. Piano]	Key Off Resonance (resonance such as the subtle sounds that occur when you release a note)	Each press of the button selects the next choice for what you will hear, in this order: Piano sound with key-off resonance added Piano sound without key-off resonance Key-off resonance by itself

### [3D] button



Button	Demo content	Sound that is played
[Piano]	Damper Resonance (the sound of other strings vibrating in sympathy with the played strings when the damper pedal is pressed)	Piano sound with damper resonance added
[E. Piano]		Piano sound without damper resonance
[Organ]		Damper resonance by itself

### [Reverb] button



Button	Demo content	Sound that is played
[Piano]	String Resonance (the sound of the strings of already-played notes sympathetically vibrating when you play a note)	Piano sound with string resonance added
[E. Piano]		Piano sound without string resonance

## Performing with a Variety of Sounds

The HP203 features over 300 different internal sounds, allowing you to enjoy performing with sounds suitable for many different types of music.

These onboard sounds are called "Tones." The Tones are divided into six different groups, each of which is assigned to a different Tone button.

The Tone "Grand Piano 1" is selected when the instrument's power is turned on.



### 1. Press a Tone button to select a tone group.

You'll hear the Tone assigned to Tone number 1 in the selected Tone Group. Try fingering the keyboard.

The display will indicate the number of the currently selected tone.



### 2. Use the [-] [+] buttons to select a sound from the tone group.

The Tone you've selected is heard when you finger the keyboard.

The next time you select this Tone button, you'll hear the tone you selected here.



**MEMO** If you don't perform any operation for a while, the indication in the display will change to the following.



**MEMO** About the Tone, refer to "Tone List" (p. 88).

**NOTE** For some sounds, there are keys that do not produce sound.

## Adjusting the Keyboard Sensitivity (Key Touch)

You can change the touch sensitivity, or response of the keys. You can adjust the keyboard touch as appropriate for the playing strength of the person who is performing.



1. Press the [Key Touch] button so it's flash.
2. Press the [-] or [+] button to select the keyboard touch.



Indicate	Button color	Description
<b>OFF</b> Fixed	Orange	The sound plays at one set volume, regardless of the force used to play the keys.
<b>-L2</b> Extra Light	Green	This setting produces the lightest keyboard touch.
<b>-L1</b> Light	Green	You can achieve fortissimo (ff) play with a less forceful touch than "medium", so the keyboard feels lighter. This setting makes it easy to play, even for children.
<b>-M-</b> Medium	Dark	This sets the standard keyboard touch. You can play with the most natural touch. This is the closest to the touch of an acoustic piano.
<b>-H1</b> Heavy	Red	You have to finger the keyboard more forcefully than "medium" in order to play fortissimo (ff), so the keyboard touch feels heavier. Dynamic fingering adds even more feeling to what you play.
<b>-H2</b> Extra Heavy	Red	This setting produces the heaviest keyboard touch.

3. Press the [Key Touch] button to return to selection of tones.



You can use the Memory Backup function to store this setting in internal memory (p. 78).

## Adding Spatial Depth to the Sound (3D Sound Control)

The HP203 provides a “3D Sound Control” function, which creates the sense of spatial depth that you experience when playing a grand piano. This function adds the natural resonance and spaciousness that are characteristic of an acoustic piano.



### 1. Press the [3D] button so it's lit.

The 3D Sound Control function will be turned on, and the sound will have more spatial depth.

### 2. While holding down the [3D] button, use the [-] [+] buttons to adjust the spatial depth of the sound.

You can adjust the spatial depth over four levels.

Increasing the value will increase the spatial depth of the sound.



**MEMO** You can use the Memory Backup function to store this setting in internal memory (p. 78).

**MEMO** You can change the way in which the 3D Sound Control function is applied (p. 65).

**NOTE** 3D Sound Control does not affect the sound from the Input jack or the sound of external devices connected to the MIDI Out connector.

**NOTE** When you turn Twin Piano on, 3D Sound Control will be turned off.

## Turning off 3D Sound Control

### 1. Press the [3D] button so its light is turned off.

## Adding Liveliness to the Sound (Dynamics Sound Control)

You can add liveliness to the sound to give it superb clarity and distinctness.



### 1. Hold down the [3D] button and press the [Reverb] button.

The display will show the type of dynamics sound control.



### 2. Use the [-] [+] buttons to select the desired sound control setting.



Indicate	Description
OFF	Dynamics sound control is turned off.
1 (Sharp)	Creates a sound with boosted bass and treble.
2 (Clear)	Produces a sound with chords in the low registers that are clear and distinct.
3 (Power)	Creates a sound with boosted bass.

### 3. Press the [3D] button or the [Reverb] button.

You will return to the normal screen.



You can use the Memory Backup function to store this setting in internal memory (p. 78).



For some sounds, this may cause distortion.



Dynamics Sound Control does not affect the sound from the Input jack or the sound of external devices connected to the MIDI Out connector.

## Adding Reverberation to Sounds (Reverb Effect)

You can apply a reverb effect to the notes you play on the keyboard. With the reverb effect, you obtain a pleasant reverberation, making it sound as if you were performing in a concert hall or similar space.



### 1. Press the [Reverb] button so it's lit.

Try fingering the keyboard.  
The reverb effect is applied to the entire tone.

## Turning Off the Reverb Effect

### 1. Press the [Reverb] button so its light is turned off.

**NOTE** Reverb will not be applied if Twin Piano is turned on with Twin Piano Mode "2" selected.

## Changing the Depth of Reverb Effect

You can select from ten levels of depth for the reverb effect.

### 1. Hold down the [Reverb] button and press the [-] or [+] button.

The depth for the reverb effect appears in the display.



**MEMO** You can use the Memory Backup function to store this setting in internal memory (p. 78).

**NOTE** You cannot make separate reverb effect depth settings for each individual tone. The effect will be applied with the same depth to all tones.

**NOTE** This will not change the reverb depth for the song that is playing back.

## Changing the Key of the Keyboard (Key Transpose)

The “Key Transpose” function lets you play a song at a different key. If you’re accompanying a singer, you can use the Transpose function to shift the pitch to a key that’s comfortable for the singer while you continue playing in the same familiar key (fingering).

You can also use this function to transpose the pitch of your playing without changing your fingering on the keyboard. For example, if the song is in a difficult key with numerous sharps (#) or flats (b), you can transpose to a key that’s easier for you to play.



On the HP203, you can transpose the pitch of just the keyboard, or the pitch of the keyboard and song together, or the pitch of just the song (Transpose Mode; p. 66). When the HP203 is shipped from the factory, it is set so that the pitch of the keyboard and song will be transposed together (“Changing the Key of the Song Playback (Playback Transpose)” (p. 47)).

### 1. Hold down the [Transpose] button and press the key corresponding to the tonic of the desired key. (In this case, the note will not sound.)

The Key Transpose setting value continues to appear in the display while the [Transpose] button is held down.



**MEMO** You can also adjust this setting by holding down the [Transpose] button and using the [-] [+] buttons.

The available range is -6–0–5 (semitone steps).

If this is set to a value other than 0, the [Transpose] button will light.

If the transpose value is not “0,” you can use the [Transpose] button to turn the Transpose function on/off.

When you release the [Transpose] button, you return to the previous screen.

**MEMO** By holding down the [Transpose] button and pressing both the [-] and [+] buttons simultaneously, the setting returns to its original value (0).

**MEMO** The transpose setting will return to “0” when you select another song.

### Example: Playing a Song in the Key of E Major After Transposition to C Major

Hold down the [Transpose] button and press the E key (since E is the tonic).

Counting from C as a reference point, one moves up four keys, including the black keys, to reach E, thus “4” appears in the display.

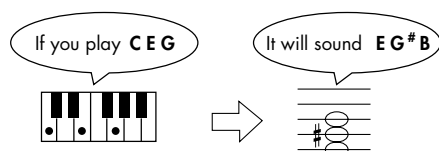



## Dividing the Keyboard for Two-person Performance (Twin Piano)

You can divide the keyboard into left and right areas so that two people can play the same range of pitches.

This means that you'll be able to use the keyboard as though it were two separate pianos. For example, this provides a convenient way for one person to follow along with another person's performance to check it.

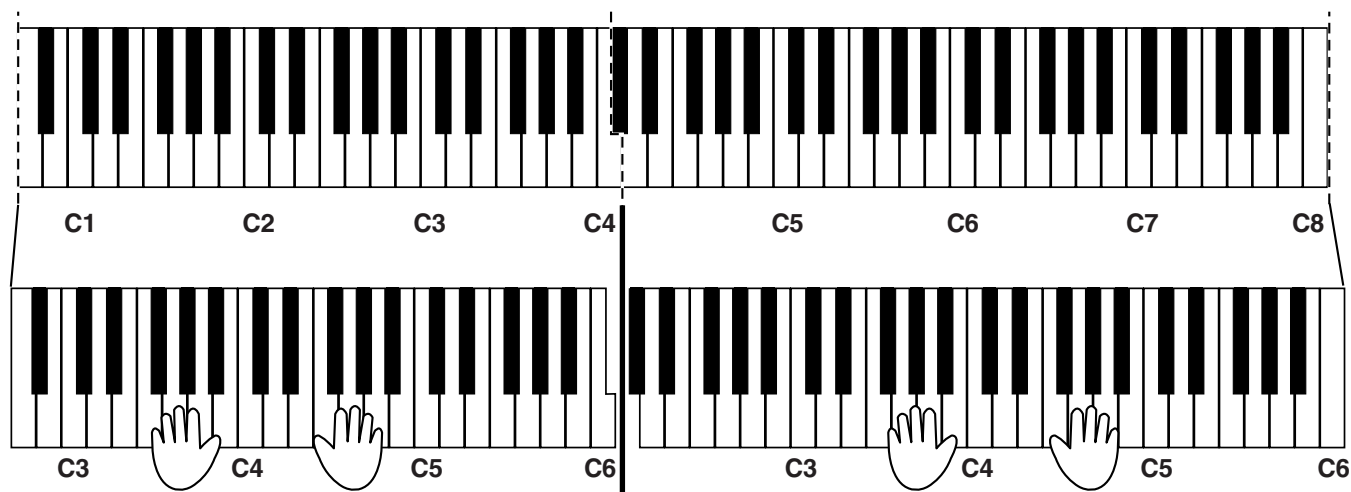

### 1. Press the [Twin Piano] button, getting its indicator to light.

The following appears in the display.



When you turn Twin Piano on, the instrument will be in the following state.

- The keyboard will be divided into left and right areas, with "middle C" located in the center of each area.
- The left and right areas will have the same sound (Grand Piano 1).
- The right pedal will be the damper pedal for the right area, and the left pedal will be the damper pedal for the left area.
- The middle pedal will be the sostenuto pedal for the right area.
- If the Split function or the Dual function was on when you turned Twin Piano on, the Split function and the Dual function will be turned off.
- 3D Sound Control and the effect will be off.

## Turning Off Twin Piano

1. Press the [Twin Piano] button so its illumination is turned off.

## Changing the Way in Which the Sound is Heard (Twin Piano Mode)

1. Hold down the [Twin Piano] button and press the [-] or [+] button.

You can choose one of the following ways in which the sound will be heard.



Indicate	Description
1	As usual, the sound will be heard from the right as you play toward the right of the keyboard, and from the left as you play toward the left.
2	Notes played in the right area will be heard from the right speaker, and notes played in the left area will be heard from the left speaker.

**NOTE** If you set Twin Piano mode to “2,” reverb will no longer be applied when you turn on Twin Piano mode.

**NOTE** For some sounds, the sound may not be split even if you set Twin Piano mode to “2.”

**MEMO** You can use the Memory Backup function to store this setting in internal memory (p. 78).

## Performing With Two Layered Tones (Dual Play)

You can play two different sounds from a single key at the same time. This method of performance is called “Dual Play.”

As an example, let’s try layering piano and strings sounds.



### 1. Hold down the [Piano] button and press the [Strings] button.

The indicators for both buttons light.

Try fingering the keyboard. Both the piano and strings sounds play.

Pressing two Tone buttons at the same time in this manner activates Dual Play.

Of the two selected tones, the one for the tone button at left is called “Tone 1” and the one for the button at right is called “Tone 2.”

**NOTE** You can’t select Dual Play if you’ve turned on Split Performance or Twin Piano.

## Turning Off Dual Play

### 1. Press any one of the Tone buttons.

Now you’ll hear only the tone of the button you pressed.

**MEMO** You can change the pitch of the Tone 2 an octave at a time. Refer to p. 66.

**MEMO** You can vary the volume-level balance of the two tones. Take a look at “Changing the Volume Balance for Dual Play” (p. 34).

**MEMO** If you press the damper pedal while using Dual Performance, the effect will be applied to both Tone 1 and Tone 2. However, you can change this setting so that the damper pedal will affect only one of the tones. Refer to “Changing How the Damper Pedal Effects Is Applied (Damper Pedal Part)” (p. 67).

**NOTE** Depending on the combination of the two tones, the effect may not be applied to Tone 2.

## Changing the Tone Variations

### Changing the Tone 1

1. Press the [-] or [+] button.

### Changing the Tone 2

1. Hold down the Tone button for the Tone 2 (the rightmost of the lit Tone buttons), and press the [-] or [+] button.

## Changing the Volume Balance for Dual Play

You can change the volume balance of the Tones 1 and 2.



1. Hold down the [Transpose] button and press the [Split] button.

The current volume balance is shown.

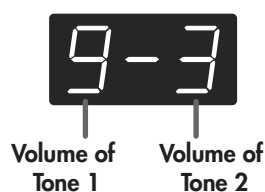

2. Press the [-] or [+] button to change the volume balance.

The volume balance will change.

If you want to return to the original volume balance, press the [-] and [+] buttons simultaneously.

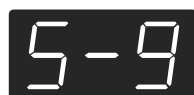

3. Press the [Transpose] button or [Split] button to return to the tone select screen.



You can use the Memory Backup function to store this setting in internal memory (p. 78).

## Performing with Different Tones in the Left and Right Sides of the Keyboard (Split Play)

Performing with the keyboard divided at a certain key into a left side and a right side is called “Split Play,” and the point at which the keyboard is divided is called the “split point.” In Split Play, you can have a different tone sound in the left and right sides.

At the factory settings the split point is set to “F # 3.” The split point key is included in the left side.

While in Split Play, a sound played in the right side is called a “right-hand tone,” and the sound played in the left side is called a “left-hand tone.”

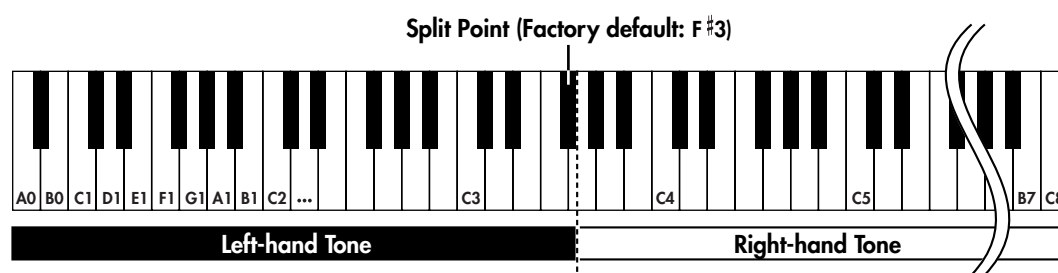

As an example, here’s how to play the tone of the [Piano] button as part of a Split performance.



### 1. Press the [Piano] button.

Now, the piano tone is selected.

### 2. Press the [Split] button, getting its indicator to light.

The keyboard will be divided into left and right sides.

The F # 3 key forms the division between the left and right sides of the keyboard.

The right-hand section of the keyboard plays piano tone, and the left-hand section plays “A. Bass+Cymbal” tone.

## Turning Off Split Play

### 1. Press the [Split] button so its illumination is turned off.

The right-hand tone becomes the tone for the entire keyboard.



When you switch from Dual Play (p. 33) to Split Play, the Tone 1 used in Dual Play is selected as the right-hand tone for Split Play.

## Switching Tone Groups and Tone Variations

### Changing the Right-hand Tone

1. Press the **Tone** button to choose a tone group.
2. Press the **[-]** or **[+]** button to select a variation tone.

### Changing the Left-hand Tone

1. Hold down the **[Split]** button and press the **Tone** button to choose a tone group.
2. Hold down the **[Split]** button and press the **[-]** or **[+]** button to select a variation tone.



You can change the pitch of the left-hand tone an octave at a time. Refer to “Changing the Pitch of the Tone in Octave Steps (Octave Shift)” (p. 66).

## Changing the Keyboard’s Split Point

You can change the split point (the key at which the keyboard is divided). The split point can be set to any value from B1 through B6. This is set to “F # 3” at the factory settings.

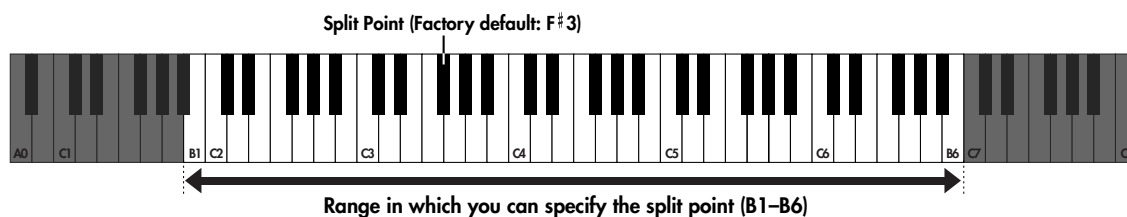

1. Hold down the **[Split]** button and press a key set as the split point.

The key you pressed becomes the split point, and appears in the display.



The key being used as the split point belongs to the left-hand section of the keyboard. The previous display will reappear when you release the key.



You can use the Memory Backup function to store this setting in internal memory (p. 78).

## Performing with the Metronome

You can perform while the metronome sounds.

HP203 provides a versatile Metronome function. You can adjust the volume or beat of the metronome.

If a song is playing, the metronome will sound at the tempo and beat of that song.

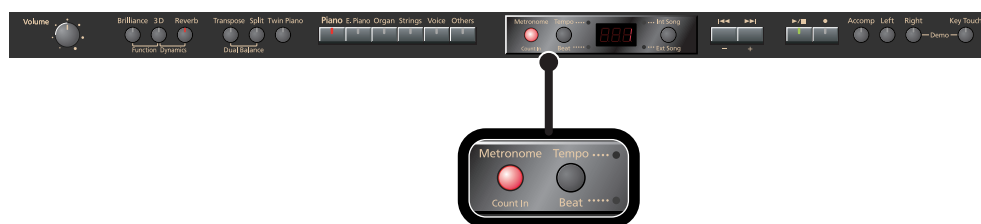

### 1. Press the [Metronome] button so it's lit.

The metronome will be heard.

The [Metronome] button flashes in red and green in time with the beat selected at that time.

The indicator lights in red on the downbeats, and in green on weak beats.



If you don't perform any operation for a while, the indication in the display will change to the following.



## Stopping the Metronome Function

### 1. Press the [Metronome] button.



You can change the sound of the metronome (p. 71).

## Changing the Tempo

### 1. Press the [Tempo/Beat] button to make the "Tempo" indicator light.

The tempo is displayed.



### 2. Press the [-] or [+] button to adjust the tempo.

Correspondence between beat and tempo display

Beat	2/2	x/4	3/8	6/8, 9/8, 12/8
Tempo Value	♩ =5-250	♩ =10-500	♩ =20-999	♩ = 7-333

## Changing the Beat

### 1. Press the [Tempo/Beat] button to make the “Beat” indicator light.

The beat is displayed.



### 2. Press the [-] or [+] button to select the beat.

Indicate	Beat	Indicate	Beat
	2/2		6/4
	Only weak beats will be sounded.		7/4
	2/4		3/8
	3/4		6/8
	4/4		9/8
	5/4		12/8

**MEMO** When you record your performance, it will record in the beat that is selected.

**MEMO** When you play back a song, the metronome’s beat will be set to the beat of that song.

**NOTE** You can’t change the metronome’s beat while a song is playing.



## Changing the Volume

The volume of the metronome can be adjusted, with 11 volume levels available. This is set to “5” when the instrument is turned on.



1. While holding down the [Metronome] button, press the [-] or [+] button. The display will indicate the metronome volume.



**MEMO** When the metronome volume is set to “0,” the metronome sound does not play.

## Sounding a Count to Keep your Timing Accurate

A “count-in” is a count that is sounded before the song begins to play. If you’re playing along with a song, you can sound a count to make it easier to synchronize your own playing with the song.



1. While holding down the [Metronome] button, press the [▶/■] button. A two-measure count sounds before the song plays.

**MEMO** A “count-down” is a count that is sounded at the end of the song’s introduction (before you begin playing the keyboard) (p. 71).

# Playing Back Songs

## Listening to Songs

Here's how to listen to the internal preset songs, songs from internal memory, or songs from USB memory (sold separately).

The HP203 provides sixty-five piano songs as internal preset songs.



You can listen to songs from floppy disk by using a separately sold floppy disk drive. By using a commercially-available CD drive, you can listen to SMF data or VIMA CD-ROMs (VIMA TUNES) on a CD-ROM, or listen to music CDs.

## Selecting a Song

### 1. Press the [Int Song/Ext Song] button.



Songs can be selected from internal memory only if the song you want to hear has already been saved in internal memory. To select a song from USB memory (sold separately), connect the USB memory containing the desired song to the external memory connector, then press the Song button (p. 21).

### 2. Press the [-] or [+] button to select the song.

The "Int Song" indicator will light if an internal preset song or internal memory song is selected, and the "Ext Song" indicator will light if a USB memory song is selected.



You can play back audio files (p. 42) from external memory, or a music CD.

## Playing the Song

### 3. Press the [▶/■] button.

The selected song will play.

The selected song is played to the end, and then playback stops.

To stop playback, press the [▶/■] button once more.

The next time you press the [▶/■] button, playback will resume from the point at which you stopped.

## Fast-forward and Rewind

- Press the [ ►► ] button to move to the beginning of the next song.
- Press the [ ◀◀ ] button to move to the beginning of the currently selected song. If you're already at the beginning of the song, you will move to the beginning of the preceding song.
- If you hold down the [ ►► ] button while a song is playing, the song will fast-forward. When you press this button, the measure number (or the time, in the case of an audio file) will be displayed for several seconds.
- If you hold down the [ ◀◀ ] button while a song is playing, the song will rewind.

### When the following appears in the display

If you have recorded a song but have not yet saved it, "dEL" will appear, blinking, when you select a song.



You cannot play back another song if memory contains an unsaved song.

If you want to delete your performance and play back the song, press the [ ● ] button.

If you don't want to delete your performance, press the [ ►/■ ] button. If you want to save your recorded performance, refer to "Saving the Songs" (p. 60).

### About the Song Select Display

The song select screen will change as follows each time you press the [Int Song/Ext Song] button.

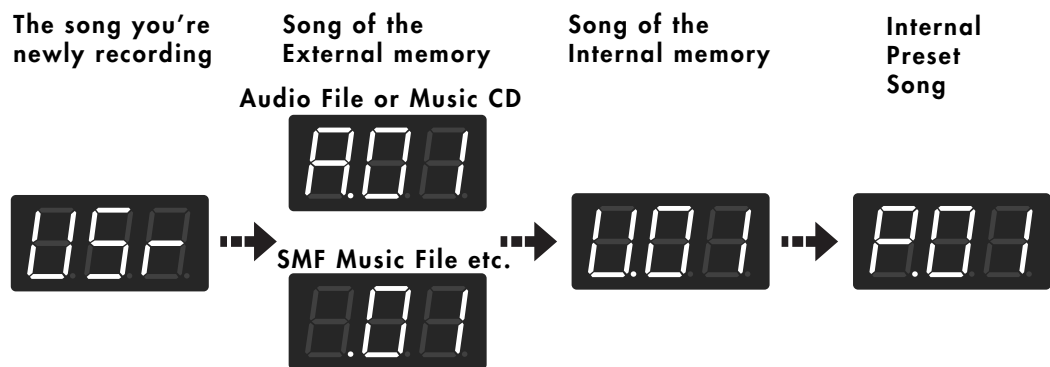

**NOTE** Indications such as "A.\*\*", ".\*\*", or "U.\*\*" will not appear if no songs are saved in external memory or internal memory, or if USB memory is not connected.

**MEMO** About the name of the internal song, refer to "Internal Song List" (p. 95).

**MEMO** If you don't perform any operation for a while, the indication in the display will change as follows.



### To select a song that's inside a folder

1. Press the [Int Song/Ext Song] button so the "Ext Song" indicator is lit.



2. Press the [-] button.

If a folder exists, a display like the following will appear.



3. Press the [▶/■] button.

The first song in the folder will be selected.



If the folder contains no songs, or if the first song is selected when you press the [-] button, the following display will appear. Here you can press the [▶/■] button to exit the folder.



### About audio files

Audio files of the following format can be played

- File extension is ".wav"
- 16-bit linear
- 44.1 kHz sampling rate

The following functions cannot be used for audio file playback.

- 3D Sound Control (p. 27)
- Reverb (p. 29)
- Tempo change (p. 46)
- Save to internal memory (p. 61)
- Recording (p. 49)
- Play back (mute) individual parts (p. 44)

\* If you execute an operation such as Save while an audio file is playing, the song may stop before the end.

## Playing Back All Songs Continuously (All Song Play)

Here's how to repeatedly play all internal songs or external memory songs in succession.



- 1. Press the [Int Song/Ext Song] button so it's lit.**
- 2. Use the [-] [+] buttons to select the first song.**
- 3. While holding down the [Int Song/Ext Song] button, press the [▶/■] button.**

The display will indicate "ALL," and the songs will play consecutively, starting with the selected song.

When the last song finishes playing, playback will return to the first song and then continue.



The songs in internal memory will play consecutively if an internal memory song is selected, and the songs in USB memory will play consecutively if a USB memory song is selected.

- 4. To stop playback, press the [▶/■] button so its indicator is turned off.**



After you've pressed the [▶/■] button to stop playback, pressing the [▶/■] button once again will resume playback from the location where you stopped, but the next song will not play back. If you want to play back all songs once again, hold down the [Int Song/Ext Song] button and press the [▶/■] button.

## Listening to Each Part Separately

When playing back internal songs or external memory songs, you can select the performance parts that will play.

You can also practice each hand separately while playing along with the song.



The performance data is assigned to the Track buttons as shown below.

The left-hand performance is assigned to the Track [Left] button, the right-hand performance is assigned to the Track [Right] button, and other performance is assigned to the Track [Accomp] button. "Tracks" are areas in which music data is held, and buttons [Left], [Right], and [Accomp] are referred to as the "track buttons."

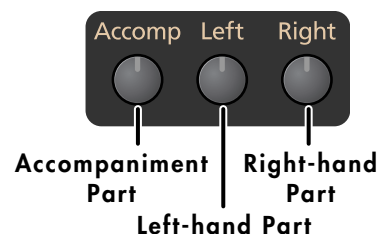

**1. Select the song that you want to play (p. 40).**

**2. Press the [▶/■] button to play the song.**

**3. Select the part that you don't want to play back.**

Press the Track [Left] button, Track [Right] button, or the Track [Accomp] button.

The button you pressed will go out, and the corresponding part will no longer be heard.

**MEMO** For example, if you want to practice the right-hand part, press the Track [Right] button so its illumination is turned off. When you play back the song, the right-hand part will not play.

**MEMO** You can select the part that will be muted when you press the [Accomp] track button and turn off its light. Please refer to p. 72.

If you again press the button you selected in step 3, so the button is lit, the sound of that part will be heard.

**NOTE** Mute settings will be cleared when you switch songs.

## Determining the Volume of a Muted Part

Here's how to adjust the volume that a part will have after you've pressed a track button to mute the playback while playing back a song.

The HP203 lets you play back a specific part at a reduced volume so you can use that part as a "guide" for your own playing.

- 1. Hold down a track button and use the [-] [+] buttons to specify the volume that the track will have when its playback is muted.**

The volume for when the track is muted will be shown while you hold down the track button.

The track mute volume can be set to any value from 0 to 80.



**NOTE** When you turn off the power, the track mute volume will be reset to "0."

## Changing the Song Playback Volume

Here's how to change the volume at which the song will play.

When you're practicing along with a song, this allows you to adjust the volume balance between your keyboard performance and the song playback.

- 1. While holding down the [▶/■] button, press the [-] [+] buttons.**

The song playback volume is displayed while you hold down the [▶/■] button.

The playback volume can be set to any value from 0 to 127.



**NOTE** When you turn off the power, the song playback volume will revert to "127."

## Adjusting the Volume of the Audio Files and Music CDs

When you select an audio file or a song from music CD, it will play back at a separately-specified volume setting.

- 1. While holding down the [▶/■] button, press the [-] [+] buttons.**

**NOTE** When you turn off the power, this playback volume will return to a setting of "64."

## Changing the Tempo of a Song

You can change the tempo at which the song plays.

When you're practicing one of the internal songs, slowing down the tempo of the playback can make it easier to play along with a difficult song.

- 1. Press the [Tempo/Beat] button so the "Tempo" button's indicator is lit.**
- 2. Use the [-] [+] buttons to change the tempo.**

## Playing Back at a Fixed Tempo (Tempo Mute)

Some of the internal preset songs have a tempo that varies during the song.

Here's how you can make these songs play back at a fixed, unchanging tempo.

- 1. While holding down the [Tempo/Beat] button, use the [-] [+] buttons to change the setting.**

Button	Value	Explanation
[+]	On	The tempo changes recorded in the song will be ignored, and the song will play at a fixed tempo.
[-]	Off	The song will play back according to the tempo changes recorded in the song.

**NOTE** When you switch songs, the Tempo Mute function will revert to the "off" setting.



## Changing the Key of the Song Playback (Playback Transpose)

The “Playback Transpose” function lets you change the key of the song playback.



- 1. Play back the song that you want to hear or play along with (p. 40).**
- 2. While holding down the [Transpose] button, use the [-] [+] buttons to adjust the pitch.**

The pitch of the song will change in semitone steps.

The Playback Transpose setting is shown while you hold down the [Transpose] button.

The range is -6–0–5 (semitone steps).

If this is set to a value other than 0, the [Transpose] button will light.

If the transpose value is other than “0,” you can use the [Transpose] button to turn the Playback Transpose function on/off.



If you hold down the [Transpose] button and press both the [-] and [+] buttons simultaneously, this setting will return to its original value (0).



The Playback Transpose function won't be applied if the Transpose Mode (p. 66) is set to “-K-” (Keyboard).



If you've selected a song from a music CD or an audio file, using Playback Transpose may affect the tonal character.



The transpose setting will return to “0” when you select another song.

## Minimizing the Center Sounds in the Playback (Center Cancel)

When playing back a commercially available CD or audio file, you can minimize the sounds that are located in the center (such as vocals).



- 1. Play back an audio file or music CD (p. 40).**
- 2. Press the [Right] track button so its illumination is turned off.**

The melody or vocal sound will be minimized.

**NOTE** For some songs, the sounds in the center may not be entirely eliminated.

**NOTE** The Center Cancel setting will be cancelled when you select another song.

### Defeating the Center Cancel function

---

- 1. Press the [Right] track button so it's lit.**

**NOTE** For some songs, using the Center Cancel function may affect the tonal character.

# Recording

You can easily record your performances.

You can play back a performance you have recorded to check what and how you played, and play melodies on the keyboard along with prerecorded accompaniment.

You can perform the following types of recording.

<b>Recording just your own keyboard performance</b>	→ "Recording Your Keyboard Performance" (p. 50)
<b>Selecting a track button and recording</b>	→ "Recording Your Performance Separately for Each Hand" (p. 52)
<b>Re-recording</b>	→ "Recording Your Performance Separately for Each Hand" (p. 52)
<b>Recording along with an internal song</b>	→ "Recording Your Playing Along with a Song" (p. 55)

## Memo

With second or later recordings, the previously recorded song is erased as the new material is recorded. When recording a new performance, it is probably a good idea to erase the previously recorded performance first (p. 57).

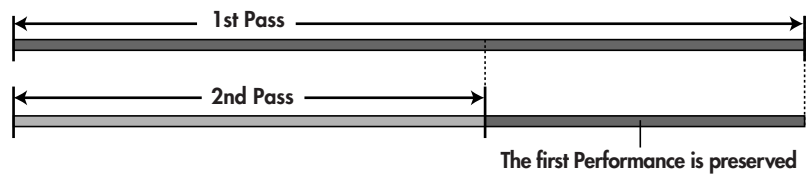

## When the following appears in the display

If you have recorded a song but have not yet saved it, "dEL" will appear, blinking, when you select a song or record a new song.

dEL

You cannot record another song if memory contains an unsaved song.

If it is OK to delete the song, press the [ ● ] button.

If you don't want to delete the song, press the [ ▶/■ ] button and save your song to internal memory or USB memory (p. 60).

## Recording Your Keyboard Performance

Here's how to record just your own keyboard performance without using an internal song.



### Performance Settings

#### 1. Press the [Int Song/Ext Song] button.

If the display does not show the following, press the [Int Song/Ext Song] button until this indication appears.



Alternatively, you can get "USR" to be displayed by holding down the [Int Song/Ext Song] button and pressing the [●] button.

#### 2. Select the Tone to be played (p. 25).

#### 3. If necessary, sound the metronome.

Press the [Metronome] button (p. 37).

While listening to the metronome, adjust the song tempo and the time signature as desired (p. 37).

### Settings for Recording

#### 4. Press the [●] button.

The [●] button lights, the [▶/■] button begins flashing, and the HP203 is put into recording standby.

If you decide not to record, press the [●] button once again.

## Starting Recording

### 5. Press the [ ▶/■ ] button or play the keyboard.

After two measures of count sound, recording begins.

Recording starts when you start playing the keyboard (without pressing the [ ▶/■ ] button). In this case, a count is not sounded.

When recording begins, the [ ● ] button and [ ▶/■ ] button will light.

**MEMO** During the count-in, the count measure is indicated in the display as “-2” then “-1.”

## Stopping Recording

### 6. Press the [ ▶/■ ] button.

Recording will stop.

## Listening to the Recorded Performance

### 7. Press the [ ◀◀ ] button.

You will return to the beginning of the performance you recorded.

### 8. Press the [ ▶/■ ] button.

The recorded performance will play back.

**MEMO** If you press the [ ▶/■ ] button while the metronome is sounding, there will be a two-measure count (“count-in”) before playback begins.

### 9. Press the [ ▶/■ ] button once again to stop playback.

**NOTE** The recorded performance will disappear when you turn off the power. If you want to keep the performance you recorded, you must save it in internal memory or USB memory. Refer to p. 60.

**NOTE** If you have not saved the performance you recorded, you won’t be able to play back another song. You’ll have to erase (p. 57) or save (p. 60) the performance before playing back another song.

## Recording Your Performance Separately for Each Hand

The HP203 recorder has three track buttons.

You can record the performance of each hand separately to different track buttons (for example, the left-hand performance to the [Left] button and the right-hand performance to the [Right] button), or you can re-record just a specific track of a previously recorded performance.

### How the track buttons correspond to the recorded performances

The recorded performances are assigned to the track buttons as follows.

- Split performance (p. 35)

Track button	Recorded performance
[Right] button	Right-hand tone
[Left] button	Left-hand tone

- Normal performance (the entire keyboard plays a single tone), Dual performance (p. 33)
- **When you record with just one recording track specified**  
The performance will be recorded on the specified track.
- **When you record with multiple recording tracks specified**  
Recording will take place in this order of priority:  
[Right] button → [Left] button → [Accomp] button.



### Settings for recording

#### 1. Press the [Int Song/Ext Song] button.

If the display does not show the following, press the [Int Song/Ext Song] button until this indication appears.



**2. Press the [ ● ] button.**

The [ ● ] button will light, the [ ▶/■ ] button indicator will flash, and the HP203 will enter recording standby mode.

If you decide not to record, press the [ ● ] button once again.

The button of the track to be recorded will flash.

**3. Press the button of each track you don't want to record, turning off its illumination.**

**MEMO** You can record to only one track button at a time.

**Recording****4. Press the [ ▶/■ ] button.**

After two measures of count sound, recording begins.

Recording starts when you start playing the keyboard (without pressing the [ ▶/■ ] button). In this case, a count is not sounded.

When recording begins, the [ ● ] button and [ ▶/■ ] button will light.

**MEMO** During the count-in, the count measure is indicated in the display as "-2" then "-1."

**5. To stop recording, press the [ ▶/■ ] button.****Recording an additional part****6. Press the [ ◀◀ ] button.**

You will return to the beginning of the recorded performance.

**7. Press the [ ● ] button.****8. Press the button of the track you want to record, making it flash.**

**NOTE** If you select a previously recorded track, that track will be overwritten by the newly recorded performance, and the previously recorded performance will be lost.

The [ ● ] button will light, the [ ▶/■ ] button will flash, and the HP203 will enter recording standby mode.

If you decide not to record, press the [ ● ] button once again.

## 9. Press the [ ▶/■ ] button.

After two measures of count sound, recording begins.

Recording starts when you start playing the keyboard (without pressing the [ ▶/■ ] button). In this case, a count is not sounded.

When recording begins, the [ ● ] button and [ ▶/■ ] button will light.

**MEMO** During the count-in, the count measure is indicated in the display as “-2” then “-1.”

**NOTE** If you record additional parts without erasing the previously recorded song, the song tempo and time signature will remain as it was when the song was first recorded.

## 10. To stop recording, press the [ ▶/■ ] button.

### Listening to the Recorded Performance

---

#### 11. Press the [ ⏮ ] button.

You will return to the beginning of the recorded performance.

#### 12. Press the [ ▶/■ ] button.

The recorded performance will play back.

#### 13. When you press the [ ▶/■ ] button once again, playback will stop.

**MEMO** After playing back a song, you can hold down one of the track buttons and press the [ ● ] button to erase the performance of only that track. At this time, the display will indicate “USr.” If you erase the performance from all tracks, the display will indicate “USr.”

**NOTE** The recorded performance will disappear when you turn off the power. If you want to keep the performance you recorded, you must save it in internal memory or USB memory. Refer to “Saving the Songs” (p. 60).

**NOTE** If you have not saved the performance you recorded, you won’t be able to play back another song. You’ll have to erase (p. 57) or save (p. 60) the performance before playing back another song.



## Recording Your Playing Along with a Song

Here's how you can play along with an internal memory song or an external memory song, and record your performance.

For example, you can listen to the left-hand part while you record the right-hand part. The performance you play on the keyboard will be recorded in place of the sound of the part you select using the track buttons.

**MEMO** The sound of the track button you selected will not be heard during recording.



### Performance Settings

#### 1. Select a song.

For details on how to select a song, refer to "Playing Back Songs" (p. 40).

If you want to record along with a song from external memory, connect USB memory or floppy disk drive before you continue (p. 21).

#### 2. Select the Tone to be played (p. 25).

#### 3. Specify the recording tempo (p. 46).

**NOTE** The performance will be recorded at the tempo of the song you selected when recording. If you record your playing along with a song, it will be recorded with the time signature of that song.

### Settings for Recording

#### 4. Press the [ ● ] button.

**5. Press the track button for the part you want to record, making the button flash.**

This allows you to record while listening to the selected song.

The [ ● ] button will light, the [ ▶/■ ] button will flash, and the HP203 will enter recording standby mode.

If you decide not to record, press the [ ● ] button once again.

**How performance parts correspond with track buttons**

Track button	Performance part
Track [Right] button	Right-hand part
Track [Left] button	Left-hand part
Track [Accomp] button	Performance data other than the right-hand part and left-hand part

**Starting Recording****6. Press the [ ▶/■ ] button.**

After a two-measure count, recording will begin.

Even if you don't press the [ ▶/■ ] button, recording will begin when you play the keyboard. In this case, a count won't be sounded.

When recording begins, the [ ● ] button and [ ▶/■ ] button will light.

**MEMO** During the count, the display will indicate the measure number as "-2" and "-1."

**Stopping Recording****7. Press the [ ▶/■ ] button.**

Recording will stop.

**Listening to the Recorded Performance****8. Press the [ ◀◀ ] button.**

You will return to the beginning of the recorded performance.

**9. Press the [ ▶/■ ] button.**

The recorded performance will play.

**10. Press the [ ▶/■ ] button once again to stop playback.**

**NOTE** The recorded performance will disappear when you turn off the power. If you want to keep the performance you recorded, you must save it in internal memory or USB memory. Refer to p. 60.

**NOTE** If you have not saved the performance you recorded, you won't be able to play back another song. You'll have to erase (p. 57) or save (p. 60) the performance before playing back another song.

## Erasing Recorded Performances

You can erase recorded performances.



### 1. Press the [Int Song/Ext Song] button.

The screen for the recorded performance will appear.

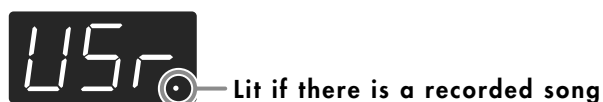

### 2. Press the [+] button.

"dEL" will start blinking in the display.



If you decide not to delete the song, press the [▶/■] button.

### 3. Press the [●] button.

The recorded performance is erased.

**MEMO** You can also erase the recorded performance by holding down the [Int Song/Ext Song] button and pressing the [●] button.

**MEMO** After playing back a song, you can hold down one of the track buttons and press the [●] button to erase the performance of only that track. At this time, the display will indicate "USr." If you erase the performance from all tracks, the display will indicate "USr".

**MEMO** A performance you recorded will be deleted when you turn off the power.

# Saving Your Performance

## Initializing the Memory

Here's how you can completely erase all songs that were saved in internal memory, USB memory (sold separately), or a floppy disk (sold separately).

**NOTE** Once an initialization is performed, all songs that have been saved in memory will be erased. The erased data cannot be recovered, so we recommend that you check the contents of memory before you proceed.

**NOTE** In order to use new USB memory or a new floppy disk with the HP203 for the first time, you'll need to initialize (format) it. USB memory or a floppy disk that has not been initialized can't be used with the HP203.

**MEMO** For details on handling USB memory, refer to "Using External Memory" (p. 21).



- 1. If you will be initializing USB memory, connect the USB memory to the external memory connector (p. 21).  
If you will be initializing a floppy disk, connect your floppy disk drive to the external memory connector, and insert the disk into the drive.**

- 2. Hold down the [Brilliance] button and press the [3D] button.**

The display will indicate "Fnc," and you'll be in Function mode.

A close-up of the digital display showing the text "Fnc" in a stylized font.

- 3. Hold down the [Int Song/Ext Song] button and use the [-] [+] buttons to make the display indicate "FMT."**

When you take your finger off the button, a screen in which you can select the memory that you want to initialize will appear.

A close-up of the digital display showing the text "FMT" in a stylized font.

#### 4. Use the [-][+] buttons to select whether you will initialize “Int” (Internal Memory) or “EXT” (USB memory or floppy disk).

Internal Memory

USB memory, floppy disk



#### 5. Press the [▶/■] button.

The display will indicate “Sur,” and the [▶/■] button and [●] button will blink.



If you decide not to initialize, press the [▶/■] button.

#### 6. Press the [●] button.

Initialization will begin.

The entire contents of the selected memory will be erased.

**NOTE**

Never turn off the power while “FMT” is blinking in the display. Doing so will destroy the memory being initialized, rendering it unusable.

**NOTE**

Initializing the HP203’s internal memory will not initialize settings other than the contents of internal memory. If you want to return settings other than the contents of internal memory to their factory-set condition, execute the Factory Reset operation (p. 79).

**NOTE**

Don’t disconnect the USB memory until USB memory initialization has been completed.

**NOTE**

While a floppy disk is being initialized, do not eject the disk from the floppy disk drive or disconnect the cable of the disk drive.

## Saving the Songs

A song you've recorded can be saved in internal memory, USB memory (sold separately) or floppy disk (sold separately).

The songs you record will be lost if you simply turn off the HP203's power before they've been saved. You'll need to save a song if you want to keep it.

A song from internal memory can also be saved to external memory, or a song from external memory can be saved to internal memory.



**NOTE** You can't save audio files or songs from a music CD.

- 1. If you want to save the song on USB memory, connect the USB memory to the external memory connector (p. 21).**

**If you want to save the song on a floppy disk, connect your floppy disk drive to the external memory connector and insert a disk into the drive.**

If you want to save a song from internal (external) memory to external (internal) memory, select the song that you want to save.

- 2. Hold down the [Brilliance] button and press the [3D] button.**

The display will indicate "Fnc" and you'll be in Function mode.

A close-up of the digital display showing the text "Fnc" in a stylized font.

- 3. Hold down the [Int Song/Ext Song] button and use the [-] [+] buttons to make the display indicate "SAv."**

When you take your hand off the button, the screen for selecting the destination to which to save the song will appear.

A close-up of the digital display showing the text "SAv" in a stylized font.

## Selecting the Save destination for the Song

- 4. Use the [-] [+] buttons to specify whether you want to save the song in "Int" (Internal Memory) or "EXT" (USB memory or floppy disk).**

Internal Memory

USB memory, floppy disk



- 5. Press the [▶/■] button.**

A screen in which you can select the save-destination number will appear.

Internal Memory

USB memory, floppy disk



- 6. Use the [-] [+] buttons to select the save-destination number.**

If the dot in the lower right of the display is lit, a song has already been saved in that number. Select a number at which no song has been saved.

If you want to erase an unwanted song and replace it with the newly saved song, select the number of the unwanted song.



— Lit if a song has been saved

## Saving the Song

- 7. Press the [▶/■] button.**

The display will indicate "Sur," and the [▶/■] button and [●] button will blink.



If you decide not to save the song, press the [▶/■] button.

- 8. Press the [●] button.**

The song will be saved.

**NOTE**

Never turn off the power while "SAV" is blinking in the display. Doing so will destroy the save-destination memory, rendering it unusable.



## Deleting a Song

Here's how you can delete a previously saved song from internal memory, USB memory or floppy disk.



If you want to delete all songs from internal memory, USB memory or floppy disk, refer to "Initializing the Memory" (p. 58).



- 1. If you're deleting a song from USB memory, connect your USB memory to the external memory connector (p. 21).**

**If you're deleting a song from floppy disk, connect your floppy disk drive to the external memory connector and insert the disk into the drive.**

- 2. Hold down the [Brilliance] button and press the [3D] button.**

The display will indicate "Fnc" and you'll be in Function mode.



- 3. Hold down the [Int Song/Ext Song] button and use the [-] [+] buttons to make the display indicate "dEL."**

When you take your finger off the button, a screen in which you can select the song to delete will appear.





## Selecting the Song to Delete

- 4. Use the [-] [+] buttons to select whether you will be deleting a song from "Int" (Internal Memory) or "EXT" (USB memory or floppy disk).**

Internal Memory

USB memory, floppy disk



- 5. Press the [▶/■] button.**

A screen in which you can select the song to delete will appear.

Internal Memory

USB memory, floppy disk



- 6. Use the [-] [+] buttons to select the song that you want to delete.**

## Deleting the Song

- 7. Press the [▶/■] button.**

The display will indicate "Sur," and the [▶/■] button and [●] button will blink.



If you decide not to delete the song, press the [▶/■] button.

- 8. Press the [●] button.**

The selected song will be deleted.

**NOTE** Never turn off the power while "dEL" is blinking in the display. Doing so will destroy the destination memory, rendering it unusable.



# Various Settings

In “Function mode” you can make various settings for performance and recording.

## Basic Operation in Function Mode

### 1. Hold down the [Brilliance] button and press the [3D] button.

The [Brilliance] button and [3D] button will light. The display will indicate “Fnc” and you’ll be in Function mode.



### 2. Press one of the blinking buttons to select the setting you want to change.

The display shows the name of the setting while you hold down the button. The value of the setting will appear when you release the button.

### 3. Use the [-] [+] buttons to change the setting.

















### 4. If you want to change a different setting, select the setting you want to change by pressing one of the buttons that were blinking before step 2.

















### 5. Press the [Brilliance] button or the [3D] button to exit Function mode.

The button indicators will return to their former state.

#### NOTE

The settings you change will return to their original state when you turn off the power (except the USB Driver and the Ext. Memory mode settings.) If you want your changes to be retained even after the power has been turned off, carry out the Memory Backup procedure (p. 78) to save the settings.

Button	Function	Page
[Reverb]	3D Mode 	p. 65
[Transpose]	Transpose Mode 	p. 66
[Split]	Octave Shift 	p. 66
[Twin Piano] (&[-][+])	Damper Pedal Part 	p. 67
	Center Pedal Function 	p. 67
	Left Pedal Function 	p. 67
[Piano]	Master Tuning 	p. 68
[E.Piano]	Temperament 	p. 68
[Organ]	Stretched Tuning 	p. 69
[Strings]	Damper Resonance 	p. 70
[Voice]	String Resonance 	p. 70
[Others]	Key Off Resonance 	p. 70
[Metronome]	Metronome Sound 	p. 71
[Tempo] (&[-][+])	Countdown 	p. 71
	Countdown Sound 	p. 71
	Countdown Part 	p. 72

Button	Function	Page
[Int Song] (&[-][+])	Save a Song 	p. 60
	Deleting a Song 	p. 62
	Initializing the Memory 	p. 58
[Accomp] (&[-][+])	Accomp Track 	p. 72
	Local Control 	p. 73
	MIDI Transmit Channel 	p. 74
	Composer MIDI Out 	p. 74
	V-LINK 	p. 75
	USB Driver 	p. 76
	External Memory Mode 	p. 76
	Master Gain 	p. 77
	Track Assign 	p. 77
	Recommended Tone 	p. 78
[Left]	Memory Backup 	p. 78
[Right]	Factory Reset 	p. 79
[Key Touch]	Hammer Response 	p. 66
[Brilliance] + [Key Touch]	Panel Lock 	p. 79

## Changing How Grand Space is Applied (3D Mode)

This specifies how 3D Sound Control (p. 27) will be applied.



### 1. Hold down the [Brilliance] button and press the [3D] button.

The display will indicate “Fnc” and you’ll be in Function mode.

### 2. Press the [Reverb] button.

The display will indicate “3d” and then the value of the setting will appear.

### 3. Use the [-] [+] buttons to change the setting.

Setting	Explanation
 Auto	When the headphones are connected, the depth effect is optimized for headphones, and when no headphones are connected, the optimal depth for speakers is applied.
 Speaker	The optimal depth for speakers is used, regardless of whether or not headphones are connected. Grand Space is also applied to the sound output from the Output connectors, making this convenient when you want to play through speakers connected to the Output connectors.
 Headphones	The optimal depth for headphones is used, regardless of whether or not headphones are connected.

## Keyboard Settings

### Specifying What the Key Transpose Will Affect (Transpose Mode)

This setting specifies what the key transpose will affect. You can use the key transpose to change the pitch of both the song and the keyboard, the pitch of only the song, or the pitch of only the keyboard.

→ Key Transpose (p. 30), Playback Transpose (p. 47)

**1. Hold down the [Brilliance] button and press the [3D] button.**

The display will indicate "Fnc" and you'll be in Function mode.

**2. Press the [Transpose] button.**

The display will indicate "trS" and then the value of the setting will appear.

**3. Use the [-] [+] buttons to change the setting.**

Setting	Explanation
	Keyboard notes
	Song playback
	Keyboard notes and song playback

### Changing the Pitch of the Tone in Octave Steps (Octave Shift)

You can change the pitch of the Tone 2 in Dual Play (p. 33) and Left-hand tone in Split Play (p. 35) an octave at a time. Altering the pitch in one-octave units in this way is called "Octave Shift."

For example, you can raise the pitch of the Left-hand Tone to the same pitch of the Right-hand Tone in Split Play.

**1. Hold down the [Brilliance] button and press the [3D] button.**

The display will indicate "Fnc" and you'll be in Function mode.

**2. Press the [Split] button.**

The display will indicate "Oct" and then the value of the setting will appear.

**3. Use the [-] [+] buttons to change the setting.**

Indication

The range of available pitch change spans from two octaves higher to two octaves lower.

The pitch is lowered one octave each time the [-] button is pressed, while each press of the [+] button raises the pitch by one octave. To return to the original pitch, press the [-] and [+] buttons simultaneously.

### Changing the Timing of Sounds According to the Force Used to Press the Keys (Hammer Response)

This adjusts how your playing strength will affect the timing at which the note sounds. This is called the "Hammer Response" function.

On an acoustic piano, pressing a key moves a hammer, which strikes a string to produce sound. If you press the key softly, the hammer will move slowly, meaning that it will take slightly longer (in comparison to a strongly-played note) from the moment you press the key until the sound is produced.

If the Hammer Response function is turned on, the time between the moment you press a key until the sound is heard will change depending on the strength with which you play. As you play more softly, this time will become longer.

**1. Hold down the [Brilliance] button and press the [3D] button.**

The display will indicate "Fnc" and you'll be in Function mode.

**2. Press the [Key Touch] button.**

The display will indicate "HrS" and then the value of the setting will appear.

**3. Use the [-] [+] buttons to change the setting.**

Setting	Explanation
OFF, 1-10	This adjusts the time from when you play a key until the piano sound is heard. Higher settings will produce slower response. If this is OFF, the sound will be heard as soon as you strike the key, regardless of how strongly you strike it.

## Pedal Settings

### Changing How the Damper Pedal Effects Is Applied (Damper Pedal Part)

When you press the damper pedal during Dual performance or Split performance, the damper pedal effect is normally applied to both tones, but you can also select the tone to which the effect is to be applied.

#### 1. Hold down the [Brilliance] button and press the [3D] button.

The display will indicate "Fnc" and you'll be in Function mode.

#### 2. Press the [Twin Piano] button.

The display will indicate "dPr" and then the value of the setting will appear.

If the display does not indicate "dPr," hold down the [Twin Piano] button and press the [-] button several times.

#### 3. Use the [-] [+] buttons to change the setting.

Setting	Explanation
	All enabled
	Applied only to the Tone 1 (in dual mode)/Right-hand Tone (in split mode)
	Applied only to the Tone 2 (in dual mode)/Left-hand Tone (in split mode)

### Changing How the Pedals Work (Center/Left Pedal Function)

When you turn on the power, the left pedal functions as the soft pedal, and the center pedal functions as the sostenuto pedal (p. 19).

You can change the function of the pedal to a variety of other operations.

#### 1. Hold down the [Brilliance] button and press the [3D] button.

The display will indicate "Fnc" and you'll be in Function mode.

#### 2. Hold down the [Twin Piano] button and use the [-] [+] buttons to select the pedal whose function you want to change.

: Center Pedal

: Left Pedal

#### 3. Use the [-] [+] buttons to change the setting.

Setting	Explanation
 Sostenuto	Sets function to sostenuto pedal. (Selectable only for the center pedal)
 Soft	Sets function to soft pedal. (Selectable only for the left pedal)
 Effects Switch	Effects can be switched on/off by pressing the pedal. When effect type is rotary, you can control the slow/fast of spinning. * The most appropriate type of effect is specified for each sound.
 Play/Stop	The pedal will have the same function as the [▶/■] button.
 Layer	Pressing the pedal will layer on Tone 2, used for Dual performance.
 Octave	Pressing the pedal will layer on a sound one octave higher.

**NOTE** For some tones, no effect will be applied.

**NOTE** If you exit Dual performance while "Layer" and "Octave" are selected, the pedal functions will also return to the factory-set settings.

## Tuning Settings

### Matching the Pitch with Other Instruments (Master Tuning)

When playing ensemble with other instruments and in other such instances, you can match the standard pitch to another instrument.

The standard pitch generally refers to the pitch of the note that's played when you finger the middle A key. For a cleaner ensemble sound while performing with one or more other instruments, ensure that each instrument's standard pitch is in tune with that of the other instruments. This tuning of all the instruments to a standard pitch is called "master tuning."

**1. Hold down the [Brilliance] button and press the [3D] button.**

The display will indicate "Fnc" and you'll be in Function mode.

**2. Press the [Piano] button.**

The display will indicate "tun" and then the value of the setting will appear.

**3. Use the [-] [+] buttons to change the setting.**



The last three digits are indicated in the display. "440.0 Hz" is indicated in the figure above.

Settings
15.3 Hz-40.0 Hz-66.2 Hz (415.3 Hz-440.0 Hz-466.2 Hz)

When the instrument is shipped from the factory, this is set to "40.0 (440.0 Hz)."

## Adjusting the Tuning (Temperament)

You can play classical music such as baroque pieces using their original tuning.

Most modern songs are composed and played with the assumption that equal temperament (the most common tuning in use today) will be used, but when classical music was composed, there were a wide variety of other tuning systems in existence. Playing a composition with its original tuning lets you enjoy the sonorities of the chords that the composer originally intended.

**1. Hold down the [Brilliance] button and press the [3D] button.**

The display will indicate "Fnc" and you'll be in Function mode.

**2. Press the [E. Piano] button.**

The display will indicate "tnP" and then the value of the setting will appear.

**3. Use the [-] [+] buttons to change the setting.**



Temperament Tonic

You can choose from among the eight tunings described below.

Setting	Temperament	Qualities
1	Equal	In this tuning, each octave is divided into twelve equal steps. Every interval produces about the same amount of slight dissonance.
2	Just (Major)	This tuning eliminates ambiguities in the fifths and thirds. It is unsuited to playing melodies and cannot be transposed, but is capable of beautiful sonorities.
3	Just (Minor)	The Just tunings differ from major and minor keys. You can get the same effect with the minor scale as with the major scale.
4	Arabic	This tuning is suitable for the music of Arabia.

Setting	Temperament	Qualities
5	Kirnberger	This is an improvement of the Meantone and Just tunings that provides a high degree of freedom of modulation. Performances are possible in all keys (III).
6	Meantone	This scale makes some compromises in just intonation, enabling transposition to other keys.
7	Pythagorean	This tuning, devised by the philosopher Pythagoras, eliminates dissonance in fourths and fifths. Dissonance is produced by third-interval chords, but melodies are euphonious.
8	Werkmeister	This temperament combines the Meantone and Pythagorean tunings. Performances are possible in all keys (first technique, III).

## Specifying the Tonic

When playing with tuning other than equal temperament, you need to specify the tonic note for tuning the song to be performed (that is, the note that corresponds to C for a major key or to A for a minor key).

If you choose an equal temperament, there's no need to select a tonic note.

4. While holding down the [E. Piano] button, press the [-] button or [+] button to select the tonic note.

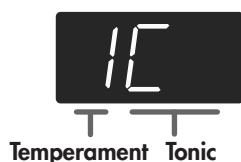

Display	C	C <sup>-</sup>	d	E <sub>-</sub>	E	F	F <sup>-</sup>	G	A <sub>-</sub>	A	b <sub>-</sub>	b
Key	C	C#	D	E <sup>b</sup>	E	F	F#	G	A <sup>b</sup>	A	B <sup>b</sup>	B

**NOTE**

When performing in ensemble with other instruments, be aware that depending on the key, there may be some shifting of the pitch.

Tune the HP203 to the fundamental pitch of the other instruments.

## Stretched Tuning

Pianos are generally tuned so that the low range is flatter and the high range is sharper than equal tempered pitches. This method of tuning is unique to the piano, and is known as "stretched tuning."

1. Hold down the [Brilliance] button and press the [3D] button.

The display will indicate "Fnc" and you'll be in Function mode.

2. Press the [Organ] button.

The display will indicate "Str" and then the value of the setting will appear.

3. Use the [-] [+] buttons to change the setting.

Setting	Explanation
	This tuning curve expands the bass and treble ends somewhat. It is suitable for performances such as piano solos.
	This is the standard tuning curve. This is suitable for when using Dual performance (p. 33) or when playing in an ensemble with other instruments.

## Sound-related Settings

### Producing Sympathetic Resonance When You Press the Damper Pedal (Damper Resonance)

You can change the volume of the damper pedal resonance. On an acoustic piano, depressing the damper pedal makes the notes you play resonate with other strings, adding rich reverberations and fatness to the sound. The damper pedal on the HP203 recreates this resonance (Damper Resonance) when depressed.

**1. Hold down the [Brilliance] button and press the [3D] button.**

The display will indicate "Fnc" and you'll be in Function mode.

**2. Press the [Strings] button.**

The display will indicate "rES" and then the value of the setting will appear.

**3. Use the [-] [+] buttons to change the setting.**

Setting	Explanation
OFF, 1-10	The resonance volume decreases as the value is lowered, while raising the value increases the volume of the Damper Resonance. The Damper Resonance function is not active when the value is set to "OFF."

### Producing the Resonance of the Strings When the Keys Are Played (String Resonance)

When you play the keys on an acoustic piano, the strings that are already playing resonate as well. The function that reproduces this effect is called "String Resonance."

**1. Hold down the [Brilliance] button and press the [3D] button.**

The display will indicate "Fnc" and you'll be in Function mode.

**2. Press the [Voice] button.**

The display will indicate "rSt" and then the value of the setting will appear.

**3. Use the [-] [+] buttons to change the setting.**

Setting	Explanation
OFF, 1-10	The resonance level decreases as the value is decreased, while increasing the value increases the amount of resonance. The String Resonance function is not active when the value is set to "OFF."

### Playing Sounds When the Keys Are Released (Key Off Resonance)

You can play the "key off" sound (the subtle sound produced when the keys are released) obtained when playing an acoustic piano.

**1. Hold down the [Brilliance] button and press the [3D] button.**

The display will indicate "Fnc" and you'll be in Function mode.

**2. Press the [Others] button.**

The display will indicate "rOF" and then the value of the setting will appear.

**3. Use the [-] [+] buttons to change the setting.**

Setting	Explanation
OFF, 1-10	The volume of the Key Off sound decreases as the value is lowered, while raising the value increases the volume of the Key Off sound. The Key Off Resonance function is not active when the value is set to "OFF."



## Metronome Settings

### Changing the Sound of the Metronome (Metronome Sound)

You can change the sound that's played by the metronome. The metronome will sound when you enter the setting screen.

**1. Hold down the [Brilliance] button and press the [3D] button.**

The display will indicate "Fnc" and you'll be in Function mode.

**2. Press the [Metronome] button.**

The display will indicate "MtS" and then the value of the setting will appear.

**3. Use the [-] [+] buttons to change the setting.**

Sound
(Click),  (Electronic),
(Voice: Japanese),  (Voice: English),
(Animal),  (Wood Block),
(Triangle & Castanets),  (Hand Claps)

## Count-down Setting

### Sounding a Count Before the Melody Begins (Countdown)

A "count-down" is when a count is sounded at the end of the song's introduction (before you begin playing the keyboard). If you will be playing along with the song, sounding a count will help you match the timing of your playing with the song.

**1. Hold down the [Brilliance] button and press the [3D] button.**

The display will indicate "Fnc" and you'll be in Function mode.

**2. Press the [Tempo] button.**

The display will indicate "Ctd" and then the value of the setting will appear.

**3. Use the [-] [+] buttons to change the setting.**

Setting	Explanation
	A count is sounded
	A count is not sounded

### Selecting the Count-down Sound (Countdown Sound)

You can select the sound that will be used to play the count-down.

**1. Hold down the [Brilliance] button and press the [3D] button.**

The display will indicate "Fnc" and you'll be in Function mode.

**2. Hold down the [Tempo] button and press the [+] button once.**

The display will indicate "Cd.S" and then the value of the setting will appear.

**3. Use the [-] [+] buttons to change the setting.**

Sound
(Voice: English),  (Voice: Japanese)

## Selecting the Part that Will Begin the Count-down (Countdown Part)

Specifies the part that will determine the beginning of the performance when adding a count-down.  
The count will sound before the selected part begins playing.



**1. Hold down the [Brilliance] button and press the [3D] button.**

The display will indicate "Fnc" and you'll be in Function mode.

**2. Hold down the [Tempo] button and press the [+] button twice.**

The display will indicate "Cd.P" and then the value of the setting will appear.

**3. Use the [-] [+] buttons to change the setting.**

Setting	Explanation
	Right-hand and left-hand parts of a song
	Left-hand part of a song
	Right-hand part of a song
1-16	Part 1-16

**NOTE** When you select another song, this setting will return to "r - L."

## Song Playback Settings

### Switching the Part that Will be Muted When You Press the [Accomp] Button (Accomp Track)

Here's how to switch the part that will be muted when you press the [Accomp] track button and turn off its light.



**1. Hold down the [Brilliance] button and press the [3D] button.**

The display will indicate "Fnc" and you'll be in Function mode.

**2. Press the [Accomp] button.**

The display will indicate "A.tr" and then the value of the setting will appear.

**3. Use the [-] [+] buttons to change the setting.**

Setting	Explanation
	Both the accompaniment and rhythm will be muted.
	Only the accompaniment will be muted. (The rhythm will not be muted.)
	Only the rhythm will be muted. (The accompaniment will not be muted.)

**NOTE** The change you make to this setting will not be applied until you select a song.

## MIDI Settings

Here you can make various MIDI-related settings for the HP203.

For more about MIDI, refer to "Connecting to MIDI Devices" (p. 82).

### Preventing Doubled Notes When Connected to a Sequencer (Local Control)

When you have a MIDI sequencer connected, set this parameter to Local Off.

Since the Thru function of your sequencer will normally be turned on, notes played on the keyboard or played back by the recorder will be transmitted to the sound generator by the two routes (1) and (2) shown in the illustration, causing notes to be sounded in duplicate or to be cut off unnaturally. To prevent this, the setting called "Local Off" is used to disconnect the route in (1).

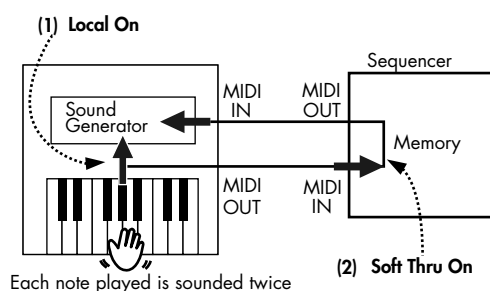

**Local On:** The keyboard and recorder are connected to the internal sound generator.

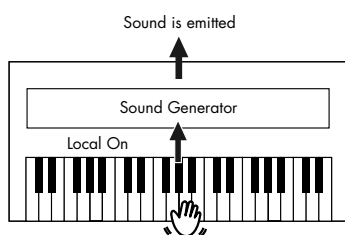

**Local Off:** The keyboard and recorder are not connected to the internal sound generator. No sound will be produced by the keyboard when it is played.

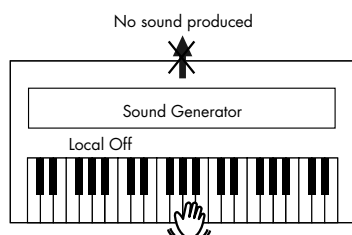

1. Hold down the [Brilliance] button and press the [3D] button.

The display will indicate "Fnc" and you'll be in Function mode.

2. Hold down the Track [Accomp] button and use the [-] [+] buttons to make the display indicate "L.Ct."

When you take your finger off the button, the display will indicate the value of the setting.

3. Use the [-] [+] buttons to change the setting.

Setting	Explanation
	The Local Control is set to On. The keyboard and recorder are connected to the internal sound generator.
	The Local Control is set to Off. The keyboard and recorder are not connected to the internal sound generator. Playing the keyboard or playing back a song will not produce sound.

**NOTE**

When connecting a unit in the Roland MT series, you don't need to switch off Local Control. MT units transmit Local Off messages when their power is switched on. If you first switch on the HP203, then the MT-series device, Local Control is automatically switched off on the HP203.

## MIDI Transmit Channel Settings (MIDI Transmit Channel)

This setting specifies the MIDI channel on which the HP203 will transmit.

MIDI uses sixteen "MIDI channels," which are numbered 1 through 16.

By connecting MIDI devices and specifying the appropriate MIDI channel for each device, you can play or select sounds on those devices.

The HP203 will receive all sixteen channels (1–16).

**1. Hold down the [Brilliance] button and press the [3D] button.**

The display will indicate "Fnc" and you'll be in Function mode.

**2. Hold down the Track [Accomp] button and use the [-] [+] buttons to make the display indicate "Ch."**

When you take your finger off the button, the display will indicate the value of the setting.

**3. Use the [-] [+] buttons to change the setting.**

Settings (Channel)
OFF, 1–16



If you turn this "OFF," the HP203 will not transmit MIDI data.



For details on connecting MIDI devices, refer to "Connecting to MIDI Devices" (p. 82).

## Sending Recorded Performance Data to a MIDI Device (Composer MIDI Out)

When Composer MIDI Out is "On," you can send performance data recorded with the HP203 to a connected MIDI device or computer.



**1. Hold down the [Brilliance] button and press the [3D] button.**

The display will indicate "Fnc" and you'll be in Function mode.

**2. Hold down the Track [Accomp] button and use the [-] [+] buttons to make the display indicate "Out."**

When you take your finger off the button, the display will indicate the value of the setting.

**3. Use the [-] [+] buttons to change the setting.**

Setting	Explanation
	Performance data is transmitted.
	Performance data is not transmitted.

## Other Settings

### Using the V-LINK Function (V-LINK)

Connecting the HP203 to a V-LINK compatible image device allows you to control the images with the HP203.

**NOTE** To prevent malfunction and/or damage to speakers or other devices, always turn down the volume, and turn off the power on all devices before making any connections.

#### V-LINK

V-LINK ( **V-LINK** ) is functionality promoted by Roland that allows linked performance of music and visual material. By using V-LINK-compatible video equipment, visual effects can be easily linked to, and made part of the expressive elements of a performance.

#### How to Use the V-LINK

1. Hold down the [Brilliance] button and press the [3D] button.

The display will indicate "Fnc" and you'll be in Function mode.





2. Hold down the Track [Accomp] button and use the [-] [+] buttons to make the display indicate "vLn."

When you take your finger off the button, the display will indicate the on/off status of the V-LINK function.



3. Press the [-] or [+] button to switch the V-LINK function on or off.

Setting	Explanation
	The V-LINK function is switched on.
	The V-LINK function is switched off.

4. Press the [Brilliance] button or the [3D] button to execute Function mode.

The button indicator will return to its previous state.

If V-LINK is on, the bars at the bottom of the display will be lit.



You can control images using the twelve keys at the left end of the keyboard.

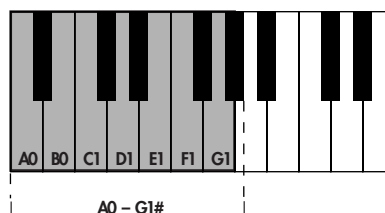

**NOTE** While V-LINK is switched on, no sound is produced when you press any of the twelve keys at the left end of the keyboard.

To disengage V-LINK, repeat steps 1–2 on the preceding page, and choose "OFF" in step 3.

## Changing the USB Driver Settings (USB Driver)

Normally, you don't need to install a driver in order to connect the HP203 to your computer. However, if some problem occurs, or if the performance is poor, using the Roland original driver may solve the problem.

Specify the USB driver you want to use, and then install the driver.

**1. Hold down the [Brilliance] button and press the [3D] button.**

The display will indicate "Fnc" and you'll be in Function mode.

**2. Hold down the Track [Accomp] button and use the [-] [+] buttons to make the display indicate "Usb."**

When you take your finger off the button, the display will indicate the value of the setting.

**3. Use the [-] [+] buttons to change the setting.**

**4. Turn on the power once again.**

Setting	Explanation
<p>Generic</p>	<p>Choose this if you want to use the standard USB driver that was included with your computer.</p> <p>Normally, you should use this mode.</p>
<p>Original</p>	<p>Choose this if you want to use a USB driver downloaded from the Roland website.</p>



For details on downloading and installing the Roland original driver, refer to the Roland website.

Roland website:

<http://www.roland.com/>



For details on connecting your computer via the USB connector, refer to "Connecting a Computer" (p. 83)



This setting is remembered even when the power is turned off.

## Changing the External Memory Setting (External Memory Mode)

In some cases, when USB memory is connected to the external memory connector, it may take longer for data to be loaded, or data may fail to be loaded successfully. If this occurs, you may be able to solve the problem by changing the external memory setting.

**1. Hold down the [Brilliance] button and press the [3D] button.**

The display will indicate "Fnc" and you'll be in Function mode.

**2. Hold down the Track [Accomp] button and use the [-] [+] buttons to make the display indicate "UMd."**

When you take your finger off the button, the display will indicate the value of the setting.

**3. Use the [-] [+] buttons to change the setting.**

**4. Turn on the power once again.**

Setting	Explanation
	Mode 1
	Mode 2



This setting is remembered even when the power is turned off.

## Adjusting the Volume (Master Gain)

If you are playing the HP203 through a connected external system, there may be cases in which the volume from your external system is too low even when the HP203's volume is turned to the maximum setting. In such cases, you can adjust the master gain setting as follows.

Adjusting the master gain will also affect the volume of the internal speakers and headphones.

**NOTE** The sound may distort if you increase the volume excessively.

### 1. Hold down the [Brilliance] button and press the [3D] button.

The display will indicate "Fnc" and you'll be in Function mode.

### 2. Hold down the Track [Accomp] button and use the [-] [+] buttons to make the display indicate "MAS."

When you take your finger off the button, the display will indicate the value of the setting.

### 3. Use the [-] [+] buttons to change the setting.

Setting
-10-0-10 dB

## Changing the Parts Assigned to the Track Buttons During SMF Playback (Track Assign)

Ordinarily, when playing back SMF music files for Roland Piano Digital instruments (p. 97), the left-hand part is assigned to the Track [Left] button, and the right-hand part is assigned to the Track [Right] button. However, right-hand and left-hand part assignments in certain SMF music files may differ.

If these are set to "Auto," and as a result you are unable to use the track buttons to control the left- and right-hand parts (p. 44) properly, change the setting to "2/1 Part" or "3/4 Part."

**NOTE** This setting can be used for SMF format songs other than the internal preset songs. It will not affect internal preset songs.



### 1. Hold down the [Brilliance] button and press the [3D] button.

The display will indicate "Fnc" and you'll be in Function mode.

### 2. Hold down the Track [Accomp] button and use the [-] [+] buttons to make the display indicate "trA."

When you take your finger off the button, the display will indicate the value of the setting.

### 3. Use the [-] [+] buttons to change the setting.

Setting	Explanation
 Auto	The part assigned to each track will be determined automatically, depending on the song file.
 2/1 Part	Part 1 will be assigned to the Track [Right] button, part 2 to the Track [Left] button, and part 3 to the Track [Accomp] button.
 3/4 Part	Part 4 will be assigned to the Track [Right] button, part 3 to the Track [Left] button, and part 1 to the Track [Accomp] button.

**NOTE** After changing this setting, try selecting the song once again.

## Switching VIMA TUNES Recommended Tones (Recommended Tone)

You can connect a commercially available USB CD drive to the HP203, and play back separately sold CD-ROMs created for the VIMA (VIMA TUNES).

Songs on VIMA CD-ROM (VIMA TUNES) are programmed with "recommended tones" suitable for each song.

When you select a song from a VIMA CD-ROM (VIMA TUNES), recommended tones will be assigned to the HP203's [Strings], [Voice], and [Others] tone buttons, and these three tone buttons will blink.

When you press a flashing Tone button, the recommended tone is then selected, enabling you to perform the selected song using a tone matched to that song as it plays back.

You can set the HP203 so that the recommended tones are automatically assigned or not assigned.



### 1. Hold down the [Brilliance] button and press the [3D] button.

The display will indicate "Fnc" and you'll be in Function mode.

### 2. Hold down the Track [Accomp] button and use the [-] [+] buttons to make the display indicate "rtn."

When you take your finger off the button, the display will indicate the value of the setting.

### 3. Use the [-] [+] buttons to change the setting.

Setting	Explanation
	When you select a song from a VIMA CD-ROM (VIMA TUNES), recommended tones will automatically be assigned to the HP203's [Strings], [Voice], and [Others] tone buttons.
	The recommended tones are not used, and only the HP203's internal tones can be selected.

This is set to "On" at the factory.

## Remembering the Settings (Memory Backup)

Normally, the settings of the various variations will revert to their default values when the power is turned off. However, you can specify that the various settings will be remembered even when the power is turned off.

This function is called "Memory Backup."

### 1. Hold down the [Brilliance] button and press the [3D] button.

The display will indicate "Fnc" and you'll be in Function mode.



### 2. Press the [Left] button.

The display will indicate "buP" and the [▶/■] button will blink.



### 3. Press the [▶/■] button.

The display will indicate "Sur," and the [▶/■] button and [●] button will blink.



If you decide not to save the settings, press the [▶/■] button.

### 4. To save the settings, press the [●] button.

**NOTE** Never turn off the power while "buP" is blinking in the display.

When the memory backup has been completed, the display will indicate "Fnc."



For details on the settings stored by the Memory Backup operation, refer to p. 96.



## Restoring the Settings to the Factory Condition (Factory Reset)

The settings you've changed in Function mode can be restored to their factory-set condition. This operation is called "Factory Reset."

Execute this operation if you want the settings you've stored using Memory Backup to be returned to their original state.

**NOTE** When you execute "Factory Reset," all settings you've stored up to that point will be cleared, and reset to their factory-set condition.

**MEMO** Executing this operation will not erase the songs from internal memory or USB memory.  
If you want to erase all songs from the HP203's internal memory and all songs from USB memory, refer to "Initializing the Memory" (p. 58).

### 1. Hold down the [Brilliance] button and press the [3D] button.

The display will indicate "Fnc" and you'll be in Function mode.



### 2. Press the [Right] button.

The display will indicate "Fct" and the [▶/■] button will blink.

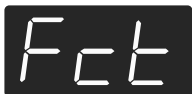

### 3. Press the [▶/■] button.

The display will indicate "Sur," and the [▶/■] button and [●] button will blink.



If you decide not to execute the Factory Reset, press the [▶/■] button.

### 4. To execute the Factory Reset, press the [●] button.

**NOTE** Never turn off the power while "Fct" is blinking in the display.

When the Factory Reset has been completed, the following display will appear.



### 5. Turn the [Volume] knob all the way toward the left to minimize the volume.

### 6. Switch the power off, then back on.

## Disabling the Buttons (Panel Lock)

If you activate the Panel Lock function, all buttons will be locked and non-functional. You can use this to prevent a child from accidentally changing the settings by inadvertently pressing buttons.

### 1. Press the [Brilliance] button and [Key Touch] button simultaneously.

Panel Lock will be activated.

All buttons will be disabled.

The following screen appears when Panel Lock is in force.



\* Pressing buttons during playback or recording of a song stops the playback or recording.

## Canceling the Panel Lock function

Once again, press the [Brilliance] button and [Key Touch] button simultaneously.



Panel Lock will be cancelled when you turn off the power.

# Connecting to Other Devices

## Connecting to Audio Equipment

You can connect audio devices to play the sound of the HP203 through the speakers of your audio system, or to record your performance on a tape recorder or other recording device.

Use phone plug audio cables (sold separately) to make connections.

\* When connection cables with resistors are used, the volume level of equipment connected to the Input jacks may be low. If this happens, use connection cables that do not contain resistors.

\* To prevent malfunction and/or damage to speakers or other devices, always turn down the volume, and turn off the power on all devices before making any connections.

## Connecting Speakers to the HP203 and Outputting Sounds

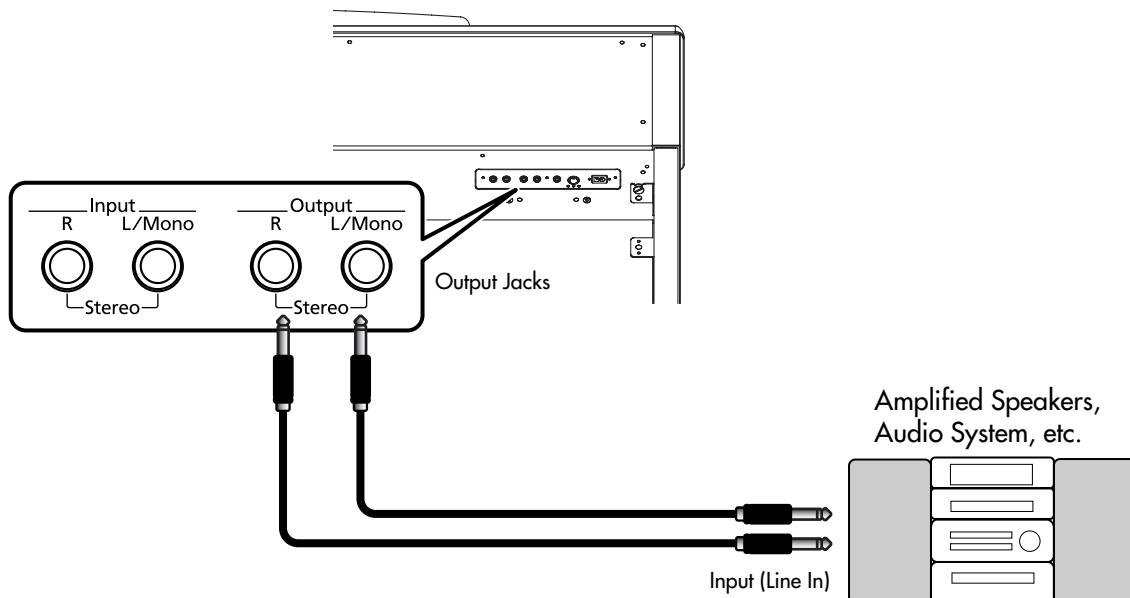

1. Turn the volume all the way down on the HP203 and on the device you're about to connect.
2. Turn off the power to the HP203 and connected speakers.
3. Use audio cables (sold separately) to make the connection.
4. Switch on the HP203.
5. Switch on the connected speakers.
6. Adjust the volume level on the HP203 and the connected speakers.

When you play the HP203's keyboard, the sound is played from the connected speakers.

### Turning Off the Power

1. Turn the volume all the way down on the HP203 and on the speakers you're about to connect.
2. Turn off the connected speakers.
3. Turn off the HP203.

## Playing Sounds of an Audio Device through the HP203

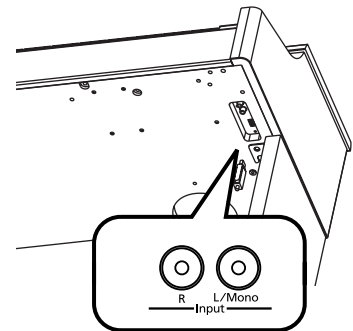
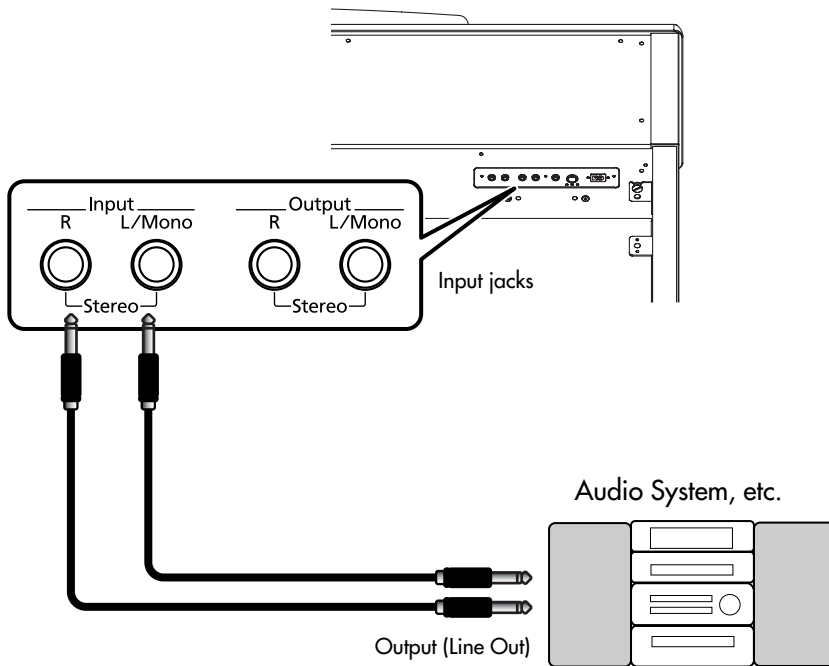

RCA pin-type Input jacks are located to the lower right of the front of the HP203. They provide a convenient way to connect portable audio devices.

- 1.** Turn the volume all the way down on the HP203 and on the audio device you're about to connect.
- 2.** Turn off the power to the HP203 and connected audio device.
- 3.** Use audio cables (sold separately) to make the connection.
- 4.** Switch on the connected audio device.
- 5.** Switch on the HP203.
- 6.** Adjust the volume level on the HP203 and the connected audio device.

The sounds from the connected audio device are played by the HP203.



Adjust the volume by using the controls of your audio device.

### Turning Off the Power

- 1.** Turn the volume all the way down on the HP203 and on the audio device you're about to connect.
- 2.** Turn off the HP203.
- 3.** Turn off the connected audio device.

## Connecting to MIDI Devices

By connecting an external MIDI device and exchanging performance data, you can control one device from the other. For instance, you can output sound from the other instrument or switch Tones on the other instrument.

### What's MIDI?

MIDI, short for "Musical Instrument Digital Interface," was developed as a universal standard for the exchange of performance data between electronic instruments and computers.

The HP203 is equipped with MIDI connectors to let it exchange performance data with external devices. These connectors can be used to connect the HP203 to an external device for even greater versatility.

## Connecting a MIDI Sequencer to the HP203

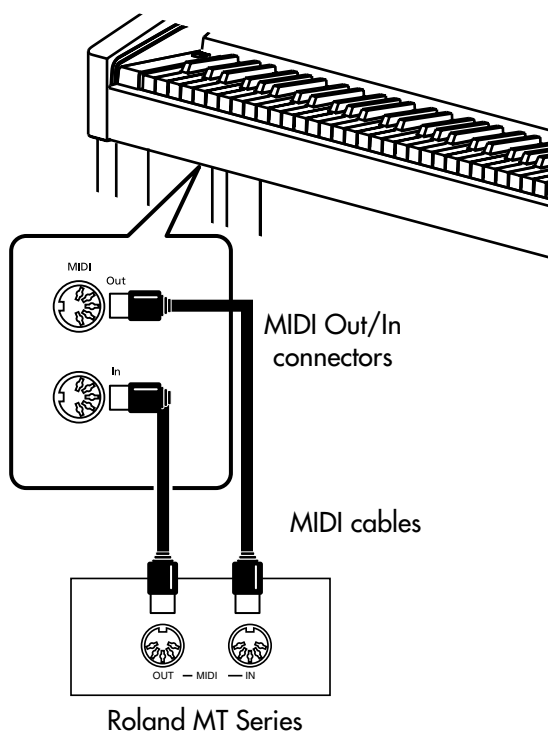

When the HP203 is connected to a MIDI sequencer, set it to "Local Off." Refer to p. 73.

## Producing Sounds from a MIDI Sound Module by Playing the HP203

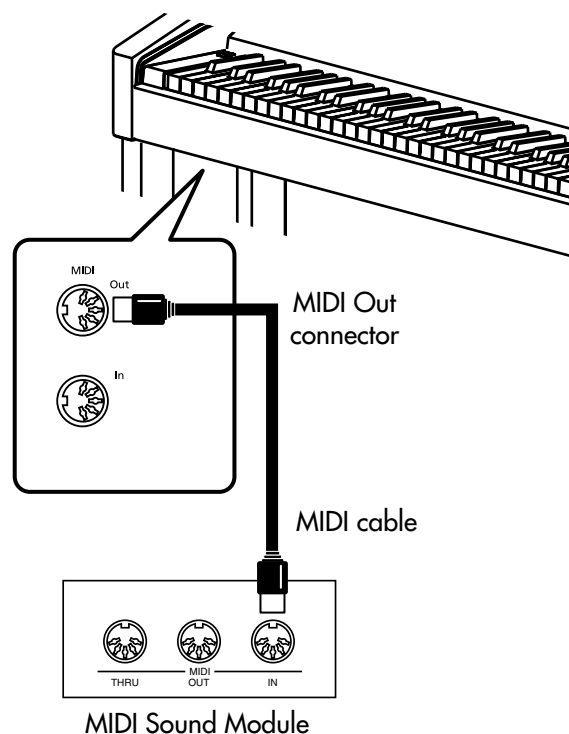

## Making the Connection

1. Turn the volume all the way down on the HP203 and on the MIDI device you're about to connect.
2. Switch off the power to the HP203 and the MIDI device you're about to connect.
3. Use a MIDI cables (sold separately) to connect the MIDI connectors to each other.
4. Switch on the power to the HP203 and the connected device.
5. Adjust the volume level on the HP203 and the connected device.
6. You should also set the MIDI transmit channel as needed (p. 74).

## Connecting a Computer

The following become possible once you connect a USB cable (available separately) between the USB (MIDI) connector located to the lower left of the front of the HP203 and the USB connector of your computer.

- You can use the HP203 to play sounds from SMF music files played back with MIDI software.
- By exchanging MIDI data with sequencer software, you can save songs recorded with the HP203 to your computer, and enjoy a variety of musical control and editing features.

Connect the HP203 to your computer as shown below.

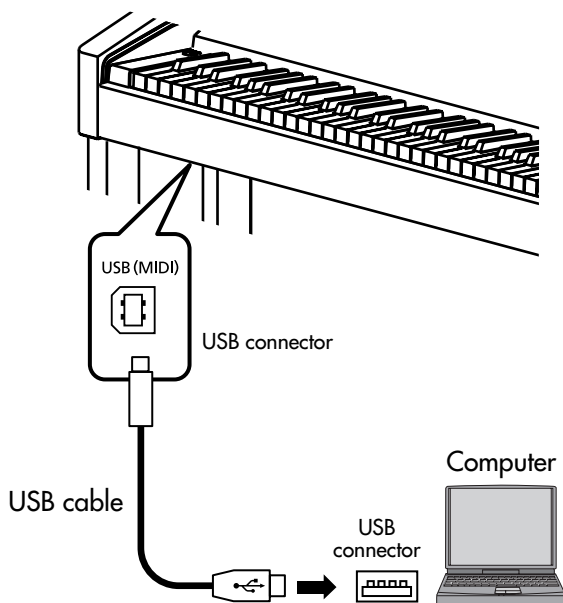

\* Refer to the Roland website for system requirements.  
Roland website: <http://www.roland.com/>

### If connection to your computer is unsuccessful...

Normally, you don't need to install a driver in order to connect the HP203 to your computer. However, if some problem occurs, or if the performance is poor, using the Roland original driver may solve the problem.

For details on downloading and installing the Roland original driver, refer to the Roland website.

Roland website: <http://www.roland.com/>

Specify the USB driver you want to use, and then install the driver. For details, refer to "Changing the USB Driver Settings (USB Driver)" (p. 76).

#### Caution

- To prevent malfunction and/or damage to speakers or other devices, always turn down the volume, and turn off the power on all devices before making any connections.
- Only MIDI data can be transmitted using USB.
- USB cables are not included. Consult your Roland dealer if you need to purchase.
- Turn on the power to the HP203 before starting up MIDI applications on the computer. Do not turn the HP203 on or off while any MIDI application is running.

# Troubleshooting

If you think there's a problem, read this first.

Symptom	Cause/Action	Page
<b>Power does not turn on</b>	Is the power cord connected correctly?	p. 16
<b>Pedal does not work, or is "stuck"</b>	Is the pedal connected correctly? Plug the cable firmly into the pedal connector.	p. 16
	If you disconnect the pedal cable from the HP203 while the power is on, the pedal effect may remain "stuck" in the On condition. You must power-off the HP203 before connecting or disconnecting the pedal cable.	—
	If you've switched the function of the soft pedal or sostenuto pedal, these pedals will not operate as the soft pedal or sostenuto pedal.	p. 67
<b>Unable to read from/write to USB memory</b>	Are you using (optional) Roland USB memory? Reliable performance cannot be guaranteed if you use non-Roland USB memory products.	—
	If you are unable to read or write USB memory successfully, change the External Memory setting to "Mode 1."	p. 76
<b>"Buzz" is heard from external devices</b>	Are the external devices connected to more than one AC power outlet? If you connect external devices, be sure to connect them to the same AC outlet.	—
<b>Device connected to the Input jacks have insufficient volume</b>	Could you be using a connection cable that contains a resistor? Use a connection cable that does not contain a resistor.	—
<b>No sound</b>		
<b>No sound</b>	Could the HP203's volume or the volume of the connected equipment be turned down?	p. 18
	Could headphones be connected? Could there be a plug inserted in a headphone jack? The speakers will not produce sound if headphones or plug are connected to the headphone jacks.	p. 20
	Has Local Control been set to "Off"? When Local Control is set to Off, no sound is produced by playing back a song. Set Local Control to On.	p. 73
<b>No sound when you play back a song</b>	Has Local Control been set to "Off"? When Local Control is set to Off, no sound is produced by playing back a song. Set Local Control to On.	p. 73
	Could the song volume be set to "0"?	p. 45
<b>No sound from the leftmost notes of the keyboard</b>	Is V-LINK switched on? When V-LINK is on, the lowest twelve notes of the keyboard are used to control the image, and will not produce sound.	p. 75
<b>No sound (when a MIDI device is connected)</b>	Are all devices powered on?	—
	Are the MIDI cables connected correctly?	p. 82
	Do the MIDI channels of the HP203 and the connected device match?	p. 74
<b>Not all the notes you play are sounded</b>	The maximum simultaneous polyphony is 128 notes. If you are playing along with a song and making heavy use of the damper pedal, the number of notes the HP203 is attempting to produce may exceed the maximum polyphony, meaning that some of the notes will drop out.	—

Symptom	Cause/Action	Page
<b>Notes don't sound right</b>		
<b>Pitch of the keyboard or song is incorrect</b>	Could you have made Key Transpose settings?	p. 30
	Is the Master Tune setting appropriate?	p. 68
	Is the setting for the Temperament correct?	p. 68
<b>Sounds are heard twice (doubled) when the keyboard is played</b>	Is the HP203 in Dual performance?	p. 33
	When the HP203 is connected to an external sequencer, set the Local Control to off. Alternatively, the sequencer could be set so its Soft Thru feature is Off.	p. 73
<b>The wrong instrument is selected when you press the [Strings], [Voice], or [Others] button</b>	<p>INSTRUMENT buttons [Strings] [Voice] [Others] also operate as buttons that select "Recommended Tones."</p> <p>With the factory settings, connecting a commercially-available CD-ROM drive to the external memory connector and selecting a song from a CD-ROM produced for the VIMA (VIMA TUNES) will automatically cause sounds appropriate for that song to be assigned to the [Strings], [Voice], and [Others] Tone buttons, so that you can select "recommended" sounds by pressing one of these buttons.</p> <p>You can also make settings so that "recommended" sounds are not automatically assigned.</p>	p. 78
<b>Effect does not apply</b>	When you are using Dual performance or Split performance, and different effects are specified for the two selected tones, the effect will not be applied to Tone 2 (when using Dual performance) or the left-hand tone (when using Split performance).	—
<b>Reverberation remains even if you defeat the Reverb effect</b>	The HP203's piano sound faithfully simulates the depth and resonance of an acoustic piano, and this may give the impression of reverberation even if you've defeated the Reverb effect.	—
<b>The sound of the higher notes suddenly changes from a certain key</b>	On an acoustic piano, the approximately one and a half octaves of notes at the top of the keyboard will continue sounding regardless of the damper pedal. These notes also have a somewhat different tonal character. HP203 faithfully simulate this characteristic of acoustic pianos. On the HP203, the range that is unaffected by the damper pedal will change according to the key transpose setting.	—
<b>High-pitched ringing is heard</b>	<p>If you hear this in headphones: Piano sounds that have a brilliant and crisp character contain substantial high-frequency components that may sound as though a metallic ringing has been added. This is because the character of an actual piano is being faithfully reproduced, and is not a malfunction. This ringing is more obtrusive if the reverb effect is applied heavily, so you may be able to minimize it by decreasing the reverb.</p> <p>If you don't hear this in headphones: It is likely that there is some other reason (such as resonances within the unit). Please contact your dealer or a nearby Roland service center.</p>	—

## Troubleshooting

Symptom	Cause/Action	Page
<b>Low notes sound wrong, or are buzzy</b>	<p>If you don't hear this in headphones: Performing at high volumes may cause the speakers or objects near the HP203 to resonate. Fluorescent lights or glass doors may also resonate sympathetically. In particular, this is more likely to occur for lower notes and higher volumes. You can take the following measures to minimize resonances.</p> <ul style="list-style-type: none"> <li>• Locate the speakers 10–15 cm away from walls or other surfaces.</li> <li>• Keep the volume down.</li> <li>• Move away from the objects that are resonating.</li> </ul> <p>If you hear this in headphones: It is likely that there is some other reason. Please contact your dealer or a nearby Roland service center.</p>	—
	<p>If you set the volume to the maximum setting, the sound may be distorted depending on how you perform. If this occurs, turn down the volume.</p>	p. 18
<b>Song does not play correctly</b>		
<b>Song won't play</b>	<p>Could the screen be indicating "dEL"?</p> <p>You can't play back an internal song if internal memory contains performance data you recorded. Erase the performance data you recorded before you play back the song.</p>	p. 41
<b>Only the sound of a particular instrument in a song does not play</b>	<p>Could a track be muted?</p> <p>If the button indicator is out, the music on that track is not heard. Press the track button so the indicator is illuminated.</p>	p. 44
<b>Can't play back a song saved in USB memory</b>	<p>Audio files of the following format can be played back.</p> <ul style="list-style-type: none"> <li>• File extension ".WAV"</li> <li>• 16-bit linear</li> <li>• "44.1 kHz" sampling rate</li> </ul>	p. 42
	<p>Is the filename extension "MID"?</p> <p>Files with other filename extensions cannot be handled as song data.</p>	—
<b>Song tempo becomes unstable</b>	<p>When playing a song from USB memory, the tempo may become unstable if there is an excessive amount of performance data.</p>	—
<b>Can't record / play back</b>		
<b>Can't record</b>	<p>Has one of the track buttons for recording been selected?</p>	p. 52 p. 55
<b>The recorded performance disappeared</b>	<p>Your recorded performance will disappear if you switch off the HP203's power or select a song. There is no way to recover the lost performance. Before you turn off the power, save your recorded performance in internal Memory.</p>	p. 60



# Error Messages

Indication	Meaning
<b>Error: 1</b>	You can only read the music file. It can not be saved.
<b>Error: 2</b>	An error occurred during writing. The external media's protect tab may be in the "Protect" (writing prohibited) position, or the external media may not yet be initialized.
<b>Error: 10</b>	No external media is inserted. Insert the external media and try again.
<b>Error: 11</b>	There is not sufficient free memory in the save destination. Either insert other external media or delete unneeded files and try again.
<b>Error: 14</b>	An error occurred during writing. The external media may be corrupted. Insert other external media and try again. Alternatively, you can initialize the external media.
<b>Error: 15</b>	The file is unreadable. The data format is not compatible with the HP203.
<b>Error: 16</b>	Data was not called up in time for playback of the song. After waiting several seconds, you may be able to play back the song by pressing the [ ▶/■ ] button again.
<b>Error: 18</b>	This audio format is not supported. Please use 44.1 kHz 16-bit linear WAV format audio files.
<b>Error: 30</b>	The internal memory capacity of the HP203 is full.
<b>Error: 40</b>	The HP203 cannot deal with the excessive MIDI data sent from the external MIDI device. Reduce the amount of MIDI data sent to the HP203.
<b>Error: 41</b>	A MIDI cable has been disconnected. Connect it properly and securely.
<b>Error: 43</b>	A MIDI transmission error has occurred. Check the MIDI cable and connected MIDI device.
<b>Error: 51</b>	There may be a problem with the system. Repeat the procedure from the beginning. If it is not solved after you have tried several times, contact the Roland service center.
<b>Error: 65</b>	The External Memory port was subjected to excessive current. Make sure that there is no problem with the external media, then turn the power off, then on again.

\* External Media: USB memory, Floppy Disk, CD-ROM, etc.

# Tone List

## Piano

1	Grand Piano1
2	Piano + Str.
3	Harpsichord
4	Grand Piano2
5	Piano+Choir
6	Honky-tonk

## E.Piano

1	Pop E.Piano
2	FM E.Piano
3	Vibraphone
4	Celesta
5	'60s E.Piano
6	Clav.
7	Morning Lite

## Organ

1	ChurchOrgan1
2	ChurchOrgan2
3	Combo Jz.Org
4	Ballad Organ
5	Nason flt 8'
6	Mellow Bars
7	Light Organ
8	Lower Organ

## Strings

1	Rich Strings
2	OrchestraStr
3	Harp
4	Violin
5	Flute
6	PizzicatoStr
7	DecayStrings *

## Voice

1	Aerial Choir
2	Jazz Scat
3	Soft Pad
4	Female Aahs
5	Male Aahs
6	Thum Voice
7	Decay Choir *
8	Dcy ChoirPad *

\* Tones indicated by "\*" are suitable for playing layered with a piano tone.

## Others

1	Nylon-str.Gt
2	Steel-str.Gt
3	AcousticBass
4	A.Bass+CymbI
5	FingeredBass

### GM2

6	STANDARD Set
7	ROOM Set
8	POWER Set
9	ELEC.Set
10	ANALOG Set
11	JAZZ Set
12	BRUSH Set
13	ORCH.Set
14	SFX Set

\* 6-14 are drum sets. Refer to p. 92-94 for details on the sounds in the drum sets.

15	Piano 1
16	Piano 1w
17	Piano 1d
18	Piano 2
19	Piano 2w
20	Piano 3
21	Piano 3w
22	Honky-tonk
23	Honky-tonk w
24	E.Piano 1
25	Detuned EP 1
26	Vintage EP
27	'60s E.Piano
28	E.Piano 2
29	Detuned EP 2
30	St.FM EP
31	EP Legend

32	EP Phase	69	Ukulele	106	RubberSyn.Bs
33	Harpsichord	70	Nylon Gt o	107	Attack Pulse
34	Coupled Hps.	71	Nylon Gt 2	108	Violin
35	Harpsi.w	72	Steel-str.Gt	109	Slow Violin
36	Harpsi.o	73	12-str.Gt	110	Viola
37	Clav.	74	Mandolin	111	Cello
38	Pulse Clav.	75	Steel+Body	112	Contrabass
39	Celesta	76	Jazz Guitar	113	Tremolo Str.
40	Glockenspiel	77	Hawaiian Gt	114	PizzicatoStr
41	Music Box	78	Clean Guitar	115	Harp
42	Vibraphone	79	Chorus Gt 1	116	Yang Qin
43	Vibraphone w	80	Mid Tone Gt	117	Timpani
44	Marimba	81	Muted Guitar	118	Strings
45	Marimba w	82	Funk Guitar1	119	Orchestra
46	Xylophone	83	Funk Guitar2	120	'60s Strings
47	TubularBells	84	Chorus Gt 2	121	Slow Strings
48	Church Bell	85	Overdrive Gt	122	Syn.Strings1
49	Carillon	86	Guitar Pinch	123	Syn.Strings3
50	Santur	87	DistortionGt	124	Syn.Strings2
51	Organ 1	88	Gt Feedback1	125	Choir 1
52	TremoloOrgan	89	Dist.Rtm Gt	126	Choir 2
53	'60s Organ	90	Gt Harmonics	127	Voice
54	Organ 2	91	Gt Feedback2	128	Humming
55	Perc.Organ 1	92	AcousticBass	129	Synth Voice
56	Chorus Organ	93	FingeredBass	130	Analog Voice
57	Perc.Organ 2	94	Finger Slap	131	OrchestraHit
58	Rock Organ	95	Picked Bass	132	Bass Hit
59	Church Org.1	96	FretlessBass	133	6th Hit
60	Church Org.2	97	Slap Bass 1	134	Euro Hit
61	Church Org.3	98	Slap Bass 2	135	Trumpet
62	Reed Organ	99	Synth Bass 1	136	Dark Trumpet
63	Puff Organ	100	WarmSyn.Bass	137	Trombone 1
64	Accordion 1	101	Synth Bass 3	138	Trombone 2
65	Accordion 2	102	Clav.Bass	139	Bright Tb
66	Harmonica	103	Hammer	140	Tuba
67	Bandoneon	104	Synth Bass 2	141	MuteTrumpet1
68	Nylon-str.Gt	105	Synth Bass 4	142	MuteTrumpet2

## Tone List

143	French Horn 1	180	Charang	217	Tinkle Bell
144	French Horn 2	181	Wire Lead	218	Agogo
145	Brass 1	182	Solo Vox	219	Steel Drums
146	Brass 2	183	5th Saw Lead	220	Woodblock
147	Synth Brass 1	184	Bass+Lead	221	Castanets
148	Synth Brass 3	185	Delayed Lead	222	Taiko
149	Analog Brass 1	186	Fantasia	223	Concert BD
150	Jump Brass	187	Warm Pad	224	Melodic Tom 1
151	Synth Brass 2	188	Sine Pad	225	Melodic Tom 2
152	Synth Brass 4	189	Polysynth	226	Synth Drum
153	Analog Brass 2	190	Space Voice	227	TR-808 Tom
154	Soprano Sax	191	Itopia	228	Elec.Perc.
155	Alto Sax	192	Bowed Glass	229	Reverse Cym.
156	Tenor Sax	193	Metallic Pad	230	Gt Fret Noise
157	Baritone Sax	194	Halo Pad	231	Gt Cut Noise
158	Oboe	195	Sweep Pad	232	BsStringSlap
159	English Horn	196	Ice Rain	233	Breath Noise
160	Bassoon	197	Soundtrack	234	Fl.Key Click
161	Clarinet	198	Crystal	235	Seashore
162	Piccolo	199	Synth Mallet	236	Rain
163	Flute	200	Atmosphere	237	Thunder
164	Recorder	201	Brightness	238	Wind
165	Pan Flute	202	Goblins	239	Stream
166	Bottle Blow	203	Echo Drops	240	Bubble
167	Shakuhachi	204	Echo Bell	241	Bird 1
168	Whistle	205	Echo Pan	242	Dog
169	Ocarina	206	Star Theme	243	Horse Gallop
170	Square Lead 1	207	Sitar 1	244	Bird 2
171	Square Lead 2	208	Sitar 2	245	Telephone 1
172	Sine Lead	209	Banjo	246	Telephone 2
173	Saw Lead 1	210	Shamisen	247	DoorCreaking
174	Saw Lead 2	211	Koto	248	Door
175	Doctor Solo	212	Taisho Koto	249	Scratch
176	Natural Lead	213	Kalimba	250	Wind Chimes
177	SequencedSaw	214	Bagpipe	251	Helicopter
178	Syn.Calliope	215	Fiddle	252	Car Engine
179	Chiffer Lead	216	Shanai	253	Car Stop

---

254	Car Pass
255	Car Crash
256	Siren
257	Train
258	Jetplane
259	Starship
260	Burst Noise
261	Applause
262	Laughing
263	Screaming
264	Punch
265	Heart Beat
266	Footsteps
267	Gun Shot
268	Machine Gun
269	Laser Gun
270	Explosion

\* In the tone group "Others" when you hold down the [-] or [+] button to switch tone in succession, the tones will stop changing at number 006 and number 015.  
To select the next sound, release the [-] or [+] button, then press it again.

# Tone List

	Standard Set	Room Set	Power Set	Electronic Set
27	High-Q	High-Q	High-Q	High-Q
28	Slap	Slap	Slap	Slap
29	Scratch Push [EXC7]	Scratch Push [EXC7]	Scratch Push [EXC7]	Scratch Push [EXC7]
30	Scratch Pull [EXC7]	Scratch Pull [EXC7]	Scratch Pull [EXC7]	Scratch Pull [EXC7]
31	Sticks	Sticks	Sticks	Sticks
32	Square Click	Square Click	Square Click	Square Click
33	Metronome Click	Metronome Click	Metronome Click	Metronome Click
34	Metronome Bell	Metronome Bell	Metronome Bell	Metronome Bell
35	Kick Drum 2	Room Kick 2	Room Kick 1	Power Kick
C2 36	Kick Drum 1	Room Kick 1	Power Kick	Electric Kick
37	Side Stick	Side Stick	Side Stick	Side Stick
38	Snare Drum	Room Snare	Power Snare	Electric Snare 1
39	Hand Clap	Hand Clap	Hand Clap	Hand Clap
40	Electric Snare 3	Electric Snare 4	Electric Snare 5	Electric Snare 2
41	Low Tom 2	Room Low Tom 2	Power Low Tom 2	Electric Low Tom 2
42	Closed Hi-Hat 1 [EXC1]	Closed Hi-Hat 2 [EXC1]	Closed Hi-Hat 2 [EXC1]	Closed Hi-Hat 2 [EXC1]
43	Low Tom 1	Room Low Tom 1	Power Low Tom 1	Electric Low Tom 1
44	Pedal Hi-Hat 1 [EXC1]	Pedal Hi-Hat 2 [EXC1]	Pedal Hi-Hat 2 [EXC1]	Pedal Hi-Hat 2 [EXC1]
45	Mid Tom 2	Room Mid Tom 2	Power Mid Tom 2	Electric Mid Tom 2
46	Open Hi-Hat 1 [EXC1]	Open Hi-Hat 2 [EXC1]	Open Hi-Hat 2 [EXC1]	Open Hi-Hat 2 [EXC1]
47	Mid Tom 1	Room Mid Tom 1	Power Mid Tom 1	Electric Mid Tom 1
C3 48	High Tom 2	Room High Tom 2	Power High Tom 2	Electric High Tom 2
49	Crash Cymbal 1	Crash Cymbal 3	Crash Cymbal 3	Crash Cymbal 3
50	High Tom 1	Room High Tom 1	Power High Tom 1	Electric High Tom 1
51	Ride Cymbal 1	Ride Cymbal 3	Ride Cymbal 3	Ride Cymbal 3
52	Chinese Cymbal 1	Chinese Cymbal 2	Chinese Cymbal 2	Reverse Cymbal
53	Ride Bell 1	Ride Bell 2	Ride Bell 2	Ride Bell 2
54	Tambourine	Tambourine	Tambourine	Tambourine
55	Splash Cymbal	Splash Cymbal	Splash Cymbal	Splash Cymbal
56	Cowbell	Cowbell	Cowbell	Cowbell
57	Crash Cymbal 2	Crash Cymbal 4	Crash Cymbal 4	Crash Cymbal 4
58	Vibraslap	Vibraslap	Vibraslap	Vibraslap
59	Ride Cymbal 2	Ride Cymbal 4	Ride Cymbal 4	Ride Cymbal 4
C4 60	High Bongo 1	High Bongo 2	High Bongo 2	High Bongo 2
61	Low Bongo 1	Low Bongo 2	Low Bongo 2	Low Bongo 2
62	Mute High Conga 1	Mute High Conga 2	Mute High Conga 2	Mute High Conga 2
63	Open High Conga	Open High Conga	Open High Conga	Open High Conga
64	Low Conga	Low Conga	Low Conga	Low Conga
65	High Timbale	High Timbale	High Timbale	High Timbale
66	Low Timbale	Low Timbale	Low Timbale	Low Timbale
67	High Agogo	High Agogo	High Agogo	High Agogo
68	Low Agogo	Low Agogo	Low Agogo	Low Agogo
69	Cabasa	Cabasa	Cabasa	Cabasa
70	Maracas	Maracas	Maracas	Maracas
71	Short High Whistle [EXC2]	Short High Whistle [EXC2]	Short High Whistle [EXC2]	Short High Whistle [EXC2]
C5 72	Long Low Whistle [EXC2]	Long Low Whistle [EXC2]	Long Low Whistle [EXC2]	Long Low Whistle [EXC2]
73	Short Guiro [EXC3]	Short Guiro [EXC3]	Short Guiro [EXC3]	Short Guiro [EXC3]
74	Long Guiro [EXC3]	Long Guiro [EXC3]	Long Guiro [EXC3]	Long Guiro [EXC3]
75	Claves	Claves	Claves	Claves
76	High Woodblock	High Woodblock	High Woodblock	High Woodblock
77	Low Woodblock	Low Woodblock	Low Woodblock	Low Woodblock
78	Mute Cuica [EXC4]	Mute Cuica [EXC4]	Mute Cuica [EXC4]	Mute Cuica [EXC4]
79	Open Cuica [EXC4]	Open Cuica [EXC4]	Open Cuica [EXC4]	Open Cuica [EXC4]
80	Mute Triangle [EXC5]	Mute Triangle [EXC5]	Mute Triangle [EXC5]	Mute Triangle [EXC5]
81	Open Triangle [EXC5]	Open Triangle [EXC5]	Open Triangle [EXC5]	Open Triangle [EXC5]
82	Shaker	Shaker	Shaker	Shaker
83	Jingle Bell	Jingle Bell	Jingle Bell	Jingle Bell
C6 84	Bar Chimes	Bar Chimes	Bar Chimes	Bar Chimes
85	Castanets	Castanets	Castanets	Castanets
86	Mute Surdo [EXC6]	Mute Surdo [EXC6]	Mute Surdo [EXC6]	Mute Surdo [EXC6]
87	Open Surdo [EXC6]	Open Surdo [EXC6]	Open Surdo [EXC6]	Open Surdo [EXC6]
88	-----	-----	-----	-----

\* ----- : No sound.

\* [EXC]: will not sound simultaneously with other percussion instruments of the same number.

	Analog Set	Jazz Set	Brush Set	Orchestra Set
	27 High-Q	High-Q	High-Q	Closed Hi-Hat 2 [EXC1]
28	Slap	Slap	Slap	Pedal Hi-Hat 2 [EXC1]
	29 Scratch Push [EXC7]	Scratch Push [EXC7]	Scratch Push [EXC7]	Open Hi-Hat 2 [EXC1]
30	Scratch Pull [EXC7]	Scratch Pull [EXC7]	Scratch Pull [EXC7]	Ride Cymbal 3
31	Sticks	Sticks	Sticks	Sticks
	32 Square Click	Square Click	Square Click	Square Click
33	Metronome Click	Metronome Click	Metronome Click	Metronome Click
	34 Metronome Bell	Metronome Bell	Metronome Bell	Metronome Bell
35	TR-808 Kick 2	Room Kick 2	Room Kick 2	Concert Bass Drum 2
C2	36 TR-808 Kick 1	Jazz Kick	Jazz Kick	Concert Bass Drum 1
	37 TR-808 Rim shot	Side Stick	Side Stick	Side Stick
38	TR-808 Snare	Jazz Snare	Brush Tap	Concert Snare Drum
	39 Hand Clap	Hand Clap	Brush Slap1	Castanets
40	Electric Snare 6	Electric Snare 7	Brush Swirl	Concert Snare Drum
	41 TR-808 Low Tom 2	Jazz Low Tom	Brush Low Tom 2	Timpani F
	42 TR-808 Closed Hi-Hat 1 [EXC1]	Closed Hi-Hat 2 [EXC1]	Brush Closed Hi-Hat [EXC1]	Timpani F#
43	TR-808 Low Tom 1	Low Tom 1	Brush Low Tom 1	Timpani G
	44 TR-808 Closed Hi-Hat 2 [EXC1]	Pedal Hi-Hat 2 [EXC1]	Brush Pedal Hi-Hat [EXC1]	Timpani G#
45	TR-808 Mid Tom 2	Mid Tom 2	Brush Mid Tom 2	Timpani A
	46 TR-808 Open Hi-Hat [EXC1]	Open Hi-Hat 2 [EXC1]	Brush Open Hi-Hat [EXC1]	Timpani A#
47	TR-808 Mid Tom 1	Jazz Mid Tom	Brush Mid Tom 1	Timpani B
C3	48 TR-808 High Tom 2	Jazz High Tom 2	Brush High Tom 2	Timpani C
	49 TR-808 Crash Cymbal	Crash Cymbal 3	Jazz Crash Cymbal	Timpani C#
50	TR-808 High Tom 1	Jazz High Tom 1	Brush High Tom 1	Timpani D
	51 Ride Cymbal 3	Ride Cymbal 3	Jazz Ride Cymbal 1	Timpani D#
52	Chinese Cymbal 2	Chinese Cymbal 2	Chinese Cymbal 2	Timpani E
	Ride Bell 2	Ride Bell 2	Jazz Ride Cymbal 2	Timpani F
53	Tambourine	Tambourine	Tambourine	Tambourine
	54 Splash Cymbal	Splash Cymbal	Splash Cymbal	Splash Cymbal
55	TR-808 Cowbell	Cowbell	Cowbell	Cowbell
	56 Crash Cymbal 4	Crash Cymbal 4	Crash Cymbal 4	Concert Cymbal 2
57	Vibraslap	Vibraslap	Vibraslap	Vibraslap
	58 Ride Cymbal4	Ride Cymbal4	Ride Cymbal4	Concert Cymbal 1
59				
C4	60 High Bongo 2	High Bongo 2	High Bongo 2	High Bongo 2
	61 Low Bongo 2	Low Bongo 2	Low Bongo 2	Low Bongo 2
62	TR-808 High Conga	Mute High Conga 2	Mute High Conga 2	Mute High Conga 2
	63 TR-808 Mid Conga	Open High Conga	Open High Conga	Open High Conga
64	TR-808 Low Conga	Low Conga	Low Conga	Low Conga
	High Timbale	High Timbale	High Timbale	High Timbale
65	Low Timbale	Low Timbale	Low Timbale	Low Timbale
	66 High Agogo	High Agogo	High Agogo	High Agogo
67	Low Agogo	Low Agogo	Low Agogo	Low Agogo
	68 Cabasa	Cabasa	Cabasa	Cabasa
69	TR-808 Maracas	Maracas	Maracas	Maracas
	70 Short High Whistle [EXC2]	Short High Whistle [EXC2]	Short High Whistle [EXC2]	Short High Whistle [EXC2]
C5	72 Long Low Whistle [EXC2]	Long Low Whistle [EXC2]	Long Low Whistle [EXC2]	Long Low Whistle [EXC2]
	73 Short Guiro [EXC3]	Short Guiro [EXC3]	Short Guiro [EXC3]	Short Guiro [EXC3]
74	Long Guiro [EXC3]	Long Guiro [EXC3]	Long Guiro [EXC3]	Long Guiro [EXC3]
	75 Claves	Claves	Claves	Claves
76	High Woodblock	High Woodblock	High Woodblock	High Woodblock
	Low Woodblock	Low Woodblock	Low Woodblock	Low Woodblock
77	78 Mute Cuica [EXC4]	Mute Cuica [EXC4]	Mute Cuica [EXC4]	Mute Cuica [EXC4]
	79 Open Cuica [EXC4]	Open Cuica [EXC4]	Open Cuica [EXC4]	Open Cuica [EXC4]
80	Mute Triangle [EXC5]	Mute Triangle [EXC5]	Mute Triangle [EXC5]	Mute Triangle [EXC5]
	81 Open Triangle [EXC5]	Open Triangle [EXC5]	Open Triangle [EXC5]	Open Triangle [EXC5]
82	Shaker	Shaker	Shaker	Shaker
83	Jingle Bell	Jingle Bell	Jingle Bell	Jingle Bell
C6	84 Bar Chimes	Bar Chimes	Bar Chimes	Bar Chimes
	85 Castanets	Castanets	Castanets	Castanets
86	Mute Surdo [EXC6]	Mute Surdo [EXC6]	Mute Surdo [EXC6]	Mute Surdo [EXC6]
	87 Open Surdo [EXC6]	Open Surdo [EXC6]	Open Surdo [EXC6]	Open Surdo [EXC6]
88	-----	-----	-----	Applause

\* ----- : No sound.

\* [EXC]: will not sound simultaneously with other percussion instruments of the same number.

# Tone List

## SFX Set

	27	-----
	28	-----
	29	-----
	30	-----
	31	-----
	32	-----
	33	-----
	34	-----
	35	-----
C2	36	-----
	37	-----
	38	-----
	39	High Q
	40	Slap
	41	Scratch Push [EXC7]
	42	Scratch Pull [EXC7]
	43	Sticks
	44	Square Click
	45	Metronome Click
	46	Metronome Bell
	47	Guitar Fret Noise
C3	48	Guitar Cutting Noise Up
	49	Guitar Cutting Noise Down
	50	String Slap of Double Bass
	51	Fl.Key Click
	52	Laughing
	53	Screaming
	54	Punch
	55	Heart Beat
	56	Footsteps 1
	57	Footsteps 2
	58	Applause
	59	Door Creaking
C4	60	Door
	61	Scratch
	62	Wind Chimes
	63	Car-Engine
	64	Car-Stop
	65	Car-Pass
	66	Car-Crash
	67	Siren
	68	Train
	69	Jet Plane
	70	Helicopter
	71	Starship
C5	72	Gun Shot
	73	Machine Gun
	74	Laser Gun
	75	Explosion
	76	Dog
	77	Horse-Gallop
	78	Birds
	79	Rain
	80	Thunder
	81	Wind
	82	Seashore
	83	Stream
C6	84	Bubble
	85	-----
	86	-----
	87	-----
	88	-----

\* ----- : No sound.

\* [EXC]: will not sound simultaneously with other percussion instruments of the same number.



# Internal Song List

1	La Fille aux Cheveux de Lin
2	La Campanella
3	Trio Grande
4	Scherzo No.2
5	Sonate No.15
6	Liebesträume 3
7	Étude, op.10-3
8	Je te veux
9	Valse, op.64-1
10	Golliwog's Cakewalk
11	Fantaisie-Impromptu
12	Arabesque 1
13	An der schönen, blauen Donau
14	Auf Flügeln des Gesanges
15	Mazurka No.5
16	Gymnopédie 1
17	Étude, op.25-1
18	Clair de Lune
19	Étude, op.10-5
20	Dr. Gradus ad Parnassum
21	Grande Valse Brillante
22	La prière d'une Vierge
23	Course en Troïka
24	To The Spring
25	Valse, op.64-2
26	Radetzky Marsch
27	Träumerei
28	Moments Musicaux 3
29	Prélude, op.28-15
30	Harmonious Blacksmith
31	Ungarische Tänze 5
32	Türkischer Marsch (Beethoven)
33	Nocturne No.2
34	Frühlingslied
35	Präludium

36	Jägerlied
37	Menuet Antique
38	Für Elise
39	Türkischer Marsch (Mozart)
40	Ständchen
41	Humoreske
42	Blumenlied
43	Alpenglöckchen
44	Menuett G dur (Beethoven)
45	Venezianisches Gondellied
46	Alpenabendröte
47	Farewell to the Piano
48	Brautchor
49	Battle of Waterloo
50	Wiener Marsch
51	Le Coucou
52	Menuett G dur (Bach)
53	Spinnerlied
54	Gavotte
55	Heidenröslein
56	Zigeuner Tanz
57	La Cinquantaine
58	Csikos Post
59	Dolly's Dreaming Awakening
60	La Violette
61	Fröhlicher Landmann
62	Sonatine op.36-1 (Clementi)
63	Sonatine op.20-1 (Kuhlau)
64	Sonatine No.5 (Beethoven)
65	Fly Flee

\* All rights reserved. Unauthorized use of this material for purposes other than private, personal enjoyment is a violation of applicable laws.

\* No data for the music that is played will be output from MIDI OUT.

# Parameters Stored in Memory Backup

Brilliance (On/Off, Brilliance)	p. 18
Key Touch	p. 26
3D Sound Control (On/Off, Depth)	p. 27
Dynamics Sound Control (Off, Type)	p. 28
Reverb (On/Off, Depth)	p. 29
Dual Balance	p. 34
Split Point	p. 36
Twin Piano Mode	p. 31
3D Mode	p. 65
Hammer Response	p. 66
Transpose Mode	p. 66
Damper Pedal Part	p. 67
Tuning	p. 68
Temperament (Temperament, Tonic)	p. 68
Stretch Tuning	p. 69
Damper Resonance	p. 70
String Resonance	p. 70
Key Off Resonance	p. 70
Metronome Sound	p. 71
Countdown Sound	p. 71
Track Assign	p. 77

## Settings stored immediately, whenever a change is made (Memory Backup procedure not needed)

USB Driver Setting	p. 76
External Memory Mode	p. 76

# Music Files That the HP203 Can Use

## What Are Music Files?

Music files contain musical information such as how long the key for a corresponding pitch is played, the force applied to the key played, and other such information. When the performance data (music file) is sent by your computer or similar device, the song will be played exactly as specified by the data. This is different than a audio CD, since the music file does not contain a recording of the sound itself. This makes it possible to change tempos and keys freely, allowing you to use it in many different ways.

## Regarding Copyright

Use of the song data supplied with the CD-ROM attached to this product for any purpose other than private, personal enjoyment without the permission of the copyright holder is prohibited by law. Additionally, this data must not be copied, nor used in a secondary copyrighted work without the permission of the copyright holder.

Please be aware that if you create derivative works that are based on existing copyrighted material, such as commercially available SMF music files, such works may violate copyright law if used for any purpose other than personal enjoyment. Roland takes no responsibility for any copyright violation you may commit by creating such works.

## The HP203 Allows You To Use the Following Music Files

### VIMA TUNES

VIMA TUNES is a Roland specification for music files that contains image and lyric data, allowing you to enjoy songs with lyrics and images simultaneously. When data bearing the "VIMA TUNES" logo is played back on a device that bears the same logo, lyrics can be shown on the screen of a connected external display or television, letting you enjoy karaoke or watch a slide show.

\* This instrument (HP203) is not able to play back VIMA TUNES images.

### SMF Music Files

SMFs (Standard MIDI Files) use a standard format for music file that was formulated so that files containing music file could be widely compatible, regardless of the manufacturer of the listening device. An enormous variety of music is available, whether it be for listening, for practicing musical instruments, for Karaoke, etc.

### General MIDI

The General MIDI is a set of recommendations which seeks to provide a way to go beyond the limitations of proprietary designs, and standardize the MIDI capabilities of sound generating devices. Sound generating devices and music files that meet the General MIDI standard bears the General MIDI logo. Music files bearing the General MIDI logo can be played back using any General MIDI sound generating unit to produce essentially the same musical performance.

### General MIDI 2

The upwardly compatible General MIDI 2 recommendations pick up where the original General MIDI left off, offering enhanced expressive capabilities, and even greater compatibility. Issues that were not covered by the original General MIDI recommendations, such as how sounds are to be edited, and how effects should be handled, have now been precisely defined. Moreover, the available sounds have been expanded. General MIDI 2 compliant sound generators are capable of reliably playing back music files that carry either the General MIDI or General MIDI 2 logo.

In some cases, the conventional form of General MIDI, which does not include the new enhancements, is referred to as "General MIDI 1" as a way of distinguishing it from General MIDI 2.

### GS Format

The GS Format is Roland's set of specifications for standardizing the performance of sound generating devices. In addition to including support for everything defined by the General MIDI, the highly compatible GS Format additionally offers an expanded number of sounds, provides for the editing of sounds, and spells out many details for a wide range of extra features, including effects such as reverb and chorus. Designed with the future in mind, the GS Format can readily include new sounds and support new hardware features when they arrive. Since it is upwardly compatible with the General MIDI, Roland's GS Format is capable of reliably playing back GM Scores equally as well as it performs GS music files (music files that have been created with the GS Format in mind).

### XG lite

XG is a tone generator format of YAMAHA Corporation, that defines the ways in which voices are expanded or edited and the structure and type of effects, in addition to the General MIDI 1 specification. XGlite is a simplified version of XG tone generation format. You can play back any XG music files using an XGlite tone generator. However, keep in mind that some music files may play back differently compared to the original files, due to the reduced set of control parameters and effects.



# Main Specifications

## HP203: Digital Piano

<Keyboard>	
Keyboard	88 keys (PHA II with Escapement)
Touch Sensitivity	Touch: 5 levels/Fixed Touch
	Hammer Response: Off/1-10
Keyboard Mode	Whole, Dual (volume balance adjustable), Split (split point adjustable), Twin piano
<Sound Generator> Conforms to GM2/GS/XG Lite	
Max. Polyphony	128 voices
Tones	306 tones (including 8 drum sets, SFX set)
Temperament	8 types, selectable tonic
Stretched Tuning	On/Off
Master Tuning	415.3-466.2 Hz (adjustable in increments of 0.1 Hz)
Transpose	Key Transpose: -6-+5 (in semitones)
	Playback Transpose (with Audio CD/Audio File): -6-+5 (in semitones)
Effects	3D (4 Levels), Dynamics (4 types), Reverb (Off/1-10), Key Off Resonance (only for piano tones, Off/1-10), String Resonance (only for piano tones, Off/1-10), Damper Resonance (only for piano tones, Off/1-10),
<Recorder>	
Tracks	3 tracks
Songs	Recorder Section: 1 song Internal Memory: Max. 99 songs
Note Storage	Approx. 30,000 notes
Control	Song Select, Play/Stop, Rec, Previous/Rewinding, Next/Fast-forwarding, Track Mute (Mute Level adjustable), Tempo, Tempo Mute, All Song Play, Count-in, Count-down, Song Volume
	Center Cancel (only for audio playback)
Tempo	Quarter note = 10 to 500
Resolution	120 ticks per quarter note
Metronome	Beat: 2/2, 0/4, 2/4, 3/4, 4/4, 5/4, 6/4, 7/4, 3/8, 6/8, 9/8, 12/8
	Volume: 0-10
	Metronome Sound: 8 types

## Main Specifications

<Internal Memory>	
<b>Songs</b>	Max. 99 songs
<b>Save Song</b>	Standard MIDI Files (Format 0)
<External Memory>	
<b>External Storage</b>	USB CD Drive (Sold Commercially <sup>*1</sup> , Read Only) USB Flash Memory (Sold Separately) USB Floppy Disk Drive (Sold Separately)
<b>Playable Software</b>	Standard MIDI Files (Format 0/1), Roland Original Format (i-Format), Audio File (WAV 44.1kHz / 16-bit Linear Format) Audio CDs (CD-DA)
<Others>	
<b>Internal Songs</b>	65 songs + 7 Tone Demo Songs
<b>Rated Power Output</b>	30 W x 2
<b>Speakers</b>	12 cm x 2
<b>Display</b>	7 segments, 3 characters LED Beat LED
<b>Control</b>	Volume, Brilliance (21 steps: -10– -1/Off/1–10)
<b>Pedal</b>	Damper (half-pedal recognition), Soft (half-pedal recognition, function assignable), Sostenuto (function assignable)
<b>Other Function</b>	Panel Lock, V-LINK
<b>Connectors</b>	AC inlet, Pedal connector, Input jacks (Front: L/Mono, R Rear: L/Mono, R), Output jacks (L/Mono, R), USB connector, MIDI connectors (IN, OUT), Phones jack (Stereo) x 2, External Memory port
<b>Power Supply</b>	AC 115 V, AC 117 V, AC 220 V, AC 230 V, AC 240 V (50/60 Hz)
<b>Power Consumption</b>	70 W
<b>Dimensions</b>	With Music Rest: 1387 (W) x 422 (D) x 1036 (H) mm 54-5/8 (W) x 16-5/8 (D) x 40-13/16 (H) inches  Without Music Rest: 1387 (W) x 422 (D) x 846 (H) mm 54-5/8 (W) x 16-5/8 (D) x 33-5/16 (H) inches
<b>Weight</b>	54 kg / 120 lbs
<b>Accessories</b>	Owner's Manual, Roland 60 Classical Piano Masterpieces, Power Cord, Headphone Hook
<b>Options</b>	USB Memory, Floppy Disk Drive, CD Drive Holder

\*1 A list of the CD drives that have been tested and found to be compatible is available on the Roland website.  
<http://www.roland.com/>

**NOTE** In the interest of product improvement, the specifications and/or appearance of this unit are subject to change without prior notice.

## Numerics

- 3D Mode ..... 65
- 3D Sound Control ..... 27

## A

- AC INLET ..... 14, 16
- Accomp Track ..... 72
- Adjuster ..... 19
- All Song Play ..... 43
- AUDIO OUTPUT L/R jack ..... 14–15

## B

- Bottom Panel ..... 15
- Brilliance Button ..... 12

## C

- CD ..... 21, 40, 48, 78, 97
- CD Drive ..... 21
- Center Cancel ..... 48
- Center Pedal ..... 19
- Center/Left Pedal Function ..... 67
- Composer MIDI Out ..... 74
- Computer ..... 83
- Connecting
  - Audio Equipment ..... 80
  - Computer ..... 83
  - MIDI devices ..... 82
  - Power Cord ..... 16
  - Speakers ..... 80
- Countdown ..... 71
- Countdown Part ..... 72
- Countdown Sound ..... 71
- CountIn ..... 39

## D

- Damper Pedal ..... 19, 67, 70
- Damper Resonance ..... 19, 64, 70
- Damper/Center/Left Pedal Part ..... 67
- Deleting
  - Saved Song ..... 62
- Demo Song ..... 22
- Display ..... 13
- Dual Play ..... 33
- Dynamics Sound Control ..... 28

## E

- Error Messages ..... 87
- External Memory ..... 21
- External Memory Connector ..... 15
- External Memory Mode ..... 76

## F

- Factory Reset ..... 79
- Floppy Disk Drive ..... 15, 40, 55
- Front Panel ..... 12
- Function Mode ..... 64

## G

- General MIDI ..... 97
- General MIDI 2 ..... 97
- GS Format ..... 97

## H

- Hammer Response ..... 66
- Headphone Hook ..... 20
- Headphones ..... 20

## K

- Key Off Resonance ..... 64, 70
- Key Touch ..... 26
- Key Transpose ..... 30
- Keyboard Sensitivity ..... 26
- Keyboard Settings ..... 66
- Keynote (Tonic) ..... 69

## L

- [Left] button ..... 44
- Left Pedal ..... 19
- List
  - Error Messages ..... 87
  - Parameters ..... 96
  - Troubleshooting ..... 84
- Local Control ..... 73

## M

- Master Gain ..... 77
- Master Tuning ..... 68
- Memory ..... 76
- Memory Backup ..... 78, 96
- Metronome ..... 37
- Metronome Sound ..... 71
- MIDI ..... 73–74, 82
- MIDI connector ..... 83
- MIDI Implementation Chart ..... 98
- MIDI IN/OUT connector ..... 15
- MIDI Transmit Ch. .... 74
- MIDI Transmit Channel ..... 74
- Music Files ..... 97
- Music Rest ..... 17

## Index

---

- O**  
Octave Shift ..... 66
- P**  
Panel Lock ..... 79  
Parameters ..... 96  
Pedal ..... 19  
PEDAL Connector ..... 14  
Pedal Cord ..... 16  
PHONES Jack ..... 15, 20  
Playback Transpose ..... 47  
Power Cord ..... 16  
Power On ..... 18  
Power Switch ..... 12, 16, 18
- R**  
Recommended Tone ..... 78  
Recording ..... 49  
Resonance ..... 70  
Right button ..... 44  
Right Pedal ..... 19
- S**  
Saving  
    Recorded Song ..... 60  
Selecting a Song ..... 40  
Settings ..... 64  
    Keyboard ..... 66  
    Metronome ..... 71  
    MIDI ..... 73  
    Pedal ..... 67  
    Remembering ..... 78  
    Song Playback ..... 72  
    Tuning ..... 68  
    USB Driver ..... 76  
SMF ..... 77, 97  
Soft Pedal ..... 19  
Sostenuto Pedal ..... 19  
Specifications ..... 99  
Split Play ..... 35  
Split Point ..... 36  
Standard Pitch ..... 68  
Stretched Tuning ..... 64, 69  
String Resonance ..... 64, 70  
System Settings ..... 64
- T**  
Temperament ..... 64, 68  
Tempo ..... 46  
Tempo Mute ..... 46  
Tone button ..... 25  
Tone Demo Song ..... 22  
Tonic ..... 69  
Track Assign ..... 77  
Track button ..... 77  
Transpose ..... 30, 47, 66  
Transpose Mode ..... 66  
Troubleshooting ..... 84  
Tuning ..... 64, 68–69  
Twin Piano ..... 31
- U**  
USB Connector ..... 15, 83  
USB Driver ..... 76  
USB Memory ..... 21, 58
- V**  
VIMA TUNES ..... 78, 97  
V-LINK ..... 75  
Volume  
    Audio File ..... 45  
    Headphones ..... 20  
    Master Gain ..... 77  
    Music CD ..... 45  
    Overall ..... 18  
    Song ..... 45  
Volume Knob ..... 12, 16, 18, 20
- X**  
XG lite ..... 97





For EU Countries

This product complies with the requirements of European Directives EMC 89/336/EEC and LVD 73/23/EEC.

For the USA

## FEDERAL COMMUNICATIONS COMMISSION RADIO FREQUENCY INTERFERENCE STATEMENT

This equipment has been tested and found to comply with the limits for a Class B digital device, pursuant to Part 15 of the FCC Rules. These limits are designed to provide reasonable protection against harmful interference in a residential installation. This equipment generates, uses, and can radiate radio frequency energy and, if not installed and used in accordance with the instructions, may cause harmful interference to radio communications. However, there is no guarantee that interference will not occur in a particular installation. If this equipment does cause harmful interference to radio or television reception, which can be determined by turning the equipment off and on, the user is encouraged to try to correct the interference by one or more of the following measures:

- Reorient or relocate the receiving antenna.
- Increase the separation between the equipment and receiver.
- Connect the equipment into an outlet on a circuit different from that to which the receiver is connected.
- Consult the dealer or an experienced radio/TV technician for help.

This device complies with Part 15 of the FCC Rules. Operation is subject to the following two conditions:

- (1) This device may not cause harmful interference, and
- (2) This device must accept any interference received, including interference that may cause undesired operation.

Unauthorized changes or modification to this system can void the users authority to operate this equipment.  
This equipment requires shielded interface cables in order to meet FCC class B Limit.

For Canada

## NOTICE

This Class B digital apparatus meets all requirements of the Canadian Interference-Causing Equipment Regulations.

## AVIS

Cet appareil numérique de la classe B respecte toutes les exigences du Règlement sur le matériel brouilleur du Canada.

For the USA

## DECLARATION OF CONFORMITY Compliance Information Statement

Model Name : HP203  
Type of Equipment : Digital Piano  
Responsible Party : Roland Corporation U.S.  
Address : 5100 S. Eastern Avenue, Los Angeles, CA 90040-2938  
Telephone : (323) 890-3700



This product must be disposed of separately  
at your local waste recycling centre.  
Do not dispose of in household waste bin.

# Information

When you need repair service, call your nearest Roland Service Center or authorized Roland distributor in your country as shown below.

## AFRICA

### EGYPT

Al Fanny Trading Office  
9, EBN Hagar A1 Askalany  
Street,  
ARD El Golf, Heliopolis,  
Cairo 11341, EGYPT  
TEL: 20-2-417-1828

### REUNION

Maison FO - YAM Marcel  
25 Rue Jules Hermann,  
Chaudron - BP79 97 491  
Ste Clotilde Cedex,  
REUNION ISLAND  
TEL: (0262) 218-429

### SOUTH AFRICA

T.O.M.S. Sound & Music  
(Pty)Ltd.  
2 ASTRON ROAD DENVER  
JOHANNESBURG ZA 2195,  
SOUTH AFRICA  
TEL: (011)417 3400  
FAX: (011)417 3462

Paul Bothner(PTY)Ltd.  
Royal Cape Park, Unit 24  
Londonderry Road, Ottery 7800  
Cape Town, SOUTH AFRICA  
TEL: (021) 799 4900

## ASIA

### CHINA

Roland Shanghai Electronics  
Co.,Ltd.  
5F. No.1500 Pingliang Road  
Shanghai 200090, CHINA  
TEL: (021) 5580-0800

Roland Shanghai Electronics  
Co.,Ltd.  
(BEIJING OFFICE)  
10F. No.18 3 Section Anhuaxili  
Chaoyang District Beijing  
100011 CHINA  
TEL: (010) 6426-5050

### HONG KONG

Tom Lee Music Co., Ltd.  
Service Division  
22-32 Pun Shan Street, Tsuen  
Wan, New Territories,  
HONG KONG  
TEL: 2415 0911

### PARSONS MUSIC LTD.

8th Floor, Railway Plaza, 39  
Chatham Road South, T.S.T,  
Kowloon, HONG KONG  
TEL: 2333 1863

### INDIA

Rivera Digitec (India) Pvt. Ltd.  
409, Nirman Kendra  
Mahalaxmi Flats Compound  
Off. Dr. Edwin Moses Road,  
Mumbai-400011, INDIA  
TEL: (022) 2493 9051

### INDONESIA

PT Citra IntiRama  
Jl. Cideng Timur No. 15J-150  
Jakarta Pusat  
INDONESIA  
TEL: (021) 6324170

### KOREA

Cosmos Corporation  
1461-9, Seocho-Dong,  
Seocho Ku, Seoul, KOREA  
TEL: (02) 3486-8855

### MALAYSIA

Roland Asia Pacific Sdn. Bhd.  
45-1, Block C2, Jalan PJU 1/39,  
Dataran Prima, 47301 Petaling  
Jaya, Selangor, MALAYSIA  
TEL: (03) 7805-3263

## PHILIPPINES

G.A. Yupangco & Co. Inc.  
339 Gil J. Puyat Avenue  
Makati, Metro Manila 1200,  
PHILIPPINES  
TEL: (02) 899 9801

## SINGAPORE

SWEET LEE MUSIC  
COMPANY PTE. LTD.  
150 Sims Drive,  
SINGAPORE 387381  
TEL: 6846-3676

## TAIWAN

ROLAND TAIWAN  
ENTERPRISE CO., LTD.  
Room 5, 9fl. No. 112 Chung  
Shan N.Road Sec.2, Taipei,  
TAIWAN, R.O.C.  
TEL: (02) 2561 3339

## THAILAND

Theera Music Co., Ltd.  
330 Soi Verng NakornKasem,  
New Road, Sumpantawongse,  
Bangkok 10100, THAILAND  
TEL: (02) 224-8821

## AUSTRALIA/ NEW ZEALAND

## AUSTRALIA/ NEW ZEALAND

Roland Corporation  
Australia Pty.,Ltd.  
38 Campbell Avenue  
Dee Why West. NSW 2099  
AUSTRALIA

For Australia  
Tel: (02) 9982 8266  
For New Zealand  
Tel: (09) 3098 715

## CENTRAL/LATIN AMERICA

## ARGENTINA

Instrumentos Musicales S.A.  
Av.Santa Fe 2055  
(1123) Buenos Aires  
ARGENTINA  
TEL: (011) 4508-2700

## BARBADOS

A&B Music Supplies LTD  
12 Webster Industrial Park  
Wildely, St.Michael, Barbados  
TEL: (246)430-1100

## BRAZIL

Roland Brasil Ltda.  
Rua San Jose, 780 Sala B  
Parque Industrial San Jose  
Cotia - Sao Paulo - SP, BRAZIL  
TEL: (011) 4615 5666

## CHILE

Comercial Fancy II S.A.  
Rut: 96.919.420-1  
Nataniel Cox #739, 4th Floor  
Santiago - Centro, CHILE  
TEL: (02) 688-9540

## COLUMBIA

Centro Musical Ltda.  
Cra 43 B No 25 A 41 Bododega 9  
Medellin, Colombia  
TEL: (574)3812529

## COSTA RICA

JUAN Bansbach Instrumentos  
Musicales  
Ave.1. Calle 11, Apartado  
10237,  
San Jose, COSTA RICA  
TEL: 258-0211

## CURACAO

Zeelandia Music Center Inc.  
Orionweg 30  
Curacao, Netherland Antilles  
TEL:(305)5926866

## DOMINICAN REPUBLIC

Instrumentos Fernando Giraldez  
Calle Proyecto Central No.3  
Ens.La Esperilla  
Santo Domingo,  
Dominican Republic  
TEL:(809) 683 0305

## ECUADOR

Mas Musica  
Rumichaca 822 y Zaruma  
Guayaquil - Ecuador  
TEL:(593-4)2302364

## EL SALVADOR

OMNI MUSIC  
75 Avenida Norte y Final  
Alameda Juan Pablo II,  
Edificio No.4010 San Salvador,  
EL SALVADOR  
TEL: 262-0788

## GUATEMALA

Casa Instrumental  
Calzada Roosevelt 34-01,zona 11  
Ciudad de Guatemala  
Guatemala  
TEL:(502) 599-2888

## HONDURAS

Almacen Pajaro Azul S.A. de C.V.  
BO.Paz Barahona  
3 Ave.11 Calle S.O  
San Pedro Sula, Honduras  
TEL: (504) 553-2029

## MARTINIQUE

Musique & Son  
Z.I.Les Mangle  
97232 Le Lamantin  
Martinique F.W.I.  
TEL: 596 596 426860

Gigamusic SARI  
10 Rte De La Folie  
97200 Fort De France  
Martinique F.W.I.  
TEL: 596 596 715222

## MEXICO

Casa Veerkamp, s.a. de c.v.  
Av. Toluca No. 323, Col. Olivar  
de los Padres 01780 Mexico  
D.F. MEXICO  
TEL: (55) 5668-6699

## NICARAGUA

Bansbach Instrumentos  
Musicales Nicaragua  
Altamira D'Este Calle Principal  
de la Farmacia 5a.Avenida  
1 Cuadra al Lago.#503  
Managua, Nicaragua  
TEL: (505)277-2557

## PANAMA

SUPRO MUNDIAL, S.A.  
Boulevard Andrews, Albrook,  
Panama City, REP. DE  
PANAMA  
TEL: 315-0101

## PARAGUAY

Distribuidora De  
Instrumentos Musicales  
J.E. Olear y ESQ. Manduvira  
Asuncion PARAGUAY  
TEL: (595) 21 492147

## PERU

Audionet  
Distribuciones Musicales SAC  
Juan Fanning 530  
Miraflores  
Lima - Peru  
TEL: (511) 4461388

## TRINIDAD

AMR Ltd  
Ground Floor  
Maritime Plaza  
Barataria Trinidad W.I.  
TEL: (868) 638 6385

## URUGUAY

Todo Musica S.A.  
Francisco Acuna de Figueroa  
1771  
C.P.: 11.800  
Montevideo, URUGUAY  
TEL: (02) 924-2335

## VENEZUELA

Instrumentos Musicales  
Allegro,C.A.  
Av.las industrias edf.Guitar  
import  
#7 zona Industrial de Turumo  
Caracas, Venezuela  
TEL: (212) 244-1122

## EUROPE

### AUSTRIA

Roland Elektronische  
Musikinstrumente HmbH.  
Austrian Office  
Eduard-Bodem-Gasse 8,  
A-6020 Innsbruck, AUSTRIA  
TEL: (0512) 26 44 260

### BELGIUM/FRANCE/ HOLLAND/ LUXEMBOURG

Roland Centre Europe N.V.  
Houtstraat 3, B-2260, Oevel  
(Westerlo) BELGIUM  
TEL: (014) 575811

### CROATIA

ART-CENTAR  
Degenova 3.  
HR - 10000 Zagreb  
TEL: (1) 466 8493

### CZECH REP.

CZECH REPUBLIC  
DISTRIBUTOR s.r.o  
Voctárova 247/16  
CZ - 180 00 PRAHA 8,  
CZECH REP.  
TEL: (2) 830 20270

### DENMARK

Roland Scandinavia A/S  
Nordhavnsvej 7, Postbox 880,  
DK-2100 Copenhagen  
DENMARK  
TEL: 3916 6200

### FINLAND

Roland Scandinavia As, Filial  
Finland  
Elannontie 5  
FIN-01510 Vantaa, FINLAND  
TEL: (09) 68 24 020

### GERMANY

Roland Elektronische  
Musikinstrumente HmbH.  
Oststrasse 96, 22844  
Norderstedt, GERMANY  
TEL: (040) 52 60090

### GREECE/CYPRUS

STOLLAS S.A.  
Music Sound Light  
155, New National Road  
Patras 26442, GREECE  
TEL: 2610 435400

### HUNGARY

Roland East Europe Ltd.  
Warehouse Area 'DEPO' Pf.83  
H-2046 Torokbalint,  
HUNGARY  
TEL: (23) 511011

### IRELAND

Roland Ireland  
G2 Calmout Park, Calmout  
Avenue, Dublin 12  
Republic of IRELAND  
TEL: (01) 4294444

### ITALY

Roland Italy S. p. A.  
Viale delle Industrie 8,  
20020 Arese, Milano, ITALY  
TEL: (02) 937-78300

## NORWAY

Roland Scandinavia Avd.  
Kontor Norge  
Lilleakerveien 2 Postboks 95  
Lilleaker N-0216 Oslo  
NORWAY  
TEL: 2273 0074

## POLAND

ROLAND POLSKA SP. Z O.O.  
UL. Gibraltaraska 4.  
PL-03 664 Warszawa  
POLAND  
TEL: (022) 679 4419

## PORTUGAL

Roland Iberia, S.L.  
Portugal Office  
Cais das Pedras, 8/9-1 Dto  
4050-465, Porto, PORTUGAL  
TEL: 22 608 00 60

## ROMANIA

FBS LINES  
Piata Libertatii 1,  
535500 Gheorgheni,  
ROMANIA  
TEL: (266) 364 609

## RUSSIA

MuTek  
Dorozhnaya ul.3,korp.6  
117 545 Moscow, RUSSIA  
TEL: (095) 981-4967

## SLOVAKIA

DAN Acoustic s.r.o.  
Povazská 18.  
SK - 940 01 Nové Zámky  
TEL: (035) 6424 330

## SPAIN

Roland Iberia, S.L.  
Paseo Garcia Faria, 33-35  
08005 Barcelona SPAIN  
TEL: 93 493 91 00

## SWEDEN

Roland Scandinavia A/S  
SWEDISH SALES OFFICE  
Danvik Center 28, 2 tr.  
S-131 30 Nacka SWEDEN  
TEL: (08) 702 00 20

## SWITZERLAND

Roland (Switzerland) AG  
Landstrasse 5, Postfach,  
CH-4452 Itingen,  
SWITZERLAND  
TEL: (061) 927-8383

## UKRAINE

EURHYTHMICS Ltd.  
P.O.Box: 37-a.  
Nedecy Str. 30  
UA - 89600 Mukachevo,  
UKRAINE  
TEL: (03131) 414-40

## UNITED KINGDOM

Roland (U.K.) Ltd.  
Atlantic Close, Swansea  
Enterprise Park, SWANSEA  
SA7 9FJ,  
UNITED KINGDOM  
TEL: (01792) 702701

## MIDDLE EAST

### BAHRAIN

Moon Stores  
No.16, Bab Al Bahrain Avenue,  
P.O.Box 247, Manama 304,  
State of BAHRAIN  
TEL: 17 211 005

### IRAN

MOCO INC.  
No.41 Nike St., Dr.Sheriyati Ave.,  
Roberoye Cerahe Mirdamad  
Tehran, IRAN  
TEL: (021) 285-4169

### ISRAEL

Halilit P. Greenspoon & Sons  
Ltd.  
8 Retzif Ha'aliya Hashnya St.  
Tel-Aviv-Yafu ISRAEL  
TEL: (03) 6823666

## JORDAN

MUSIC HOUSE CO. LTD.  
FREDDY FOR MUSIC  
P. O. Box 922846  
Amman 11192 JORDAN  
TEL: (06) 5692696

## KUWAIT

EASA HUSAIN AL-YOUSIFI  
& SONS CO.  
Abdullah Salem Street,  
Safat, KUWAIT  
TEL: 243-6399

## LEBANON

Chahine S.A.L.  
Gerge Zeidan St., Chahine  
Bldg., Achrafieh, P.O.Box: 16-  
5857  
Beirut, LEBANON  
TEL: (01) 20-1441

## OMAN

TALENTZ CENTRE L.L.C.  
Malatan House No.1  
Al Noor Street, Ruwi  
SULTANATE OF OMAN  
TEL: 2478 3443

## QATAR

Al Emadi Co. (Badie Studio &  
Stores)  
P.O. Box 62, Doha, QATAR  
TEL: 4423-554

## SAUDI ARABIA

aDawlah Universal  
Electronics APL  
Corniche Road, Aldossary  
Bldg., 1st Floor, Alkhorbar,  
SAUDI ARABIA

P.O.Box 2154, Alkhorbar 31952  
SAUDI ARABIA  
TEL: (03) 898 2081

## SYRIA

Technical Light & Sound  
Center  
Rawda, Abdul Qader Zajzari St.  
Bldg. No. 21, P.O.BOX 13520,  
Damascus, SYRIA  
TEL: (011) 223-5384

## TURKEY

ZUHAL DIS TICARET A.S.  
Zihaf Dede Cad. No.37  
Beyoglu - Istanbul / TURKEY  
TEL: (0212) 249 85 10

## U.A.E.

Zak Electronics & Musical  
Instruments Co. L.L.C.  
Zabeel Road, Al Sherooq Bldg.,  
No. 14, Grand Floor, Dubai,  
U.A.E.  
TEL: (04) 3360715

## NORTH AMERICA

### CANADA

Roland Canada Ltd.  
(Head Office)  
5480 Parkwood Way  
Richmond B. C., V6V 2M4  
CANADA  
TEL: (604) 270 6626

Roland Canada Ltd.  
(Toronto Office)  
170 Admiral Boulevard  
Mississauga On L5T 2N6  
CANADA  
TEL: (905) 362 9707

### U. S. A.

Roland Corporation U.S.  
5100 S. Eastern Avenue  
Los Angeles, CA 90040-2938,  
U. S. A.  
TEL: (323) 890 3700



Roland®



\* 0 4 4 5 3 8 0 1 - 0 2 \*

04453801

06-12-2N